

TOP DEAL

KSTOOLS

WWW.KSTOOLS.COM

No Limits!

VÅR NYCKELKOMPETENS:

KVALITET TILL SLAGKRAFTIGT PRIS!

EVOLUTION
SERIES



Komplett
stycklista

917.0255

1/4" + 3/8" + 1/2" + 5/16"

255 DELAR
FÖR ENDAST

1660,-

EDELSTAHL
ROSTFREI

i 397
Mer information

P₁₀

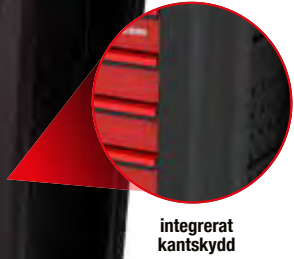
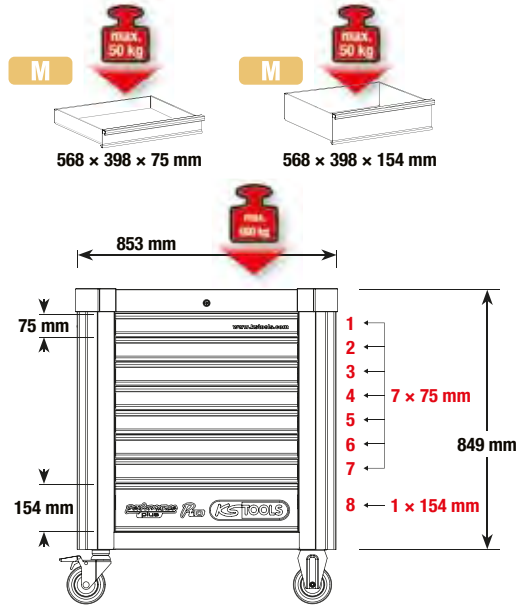

VÄLJ DITT KRAFTPAKET

810.7397

i 397
Mer information

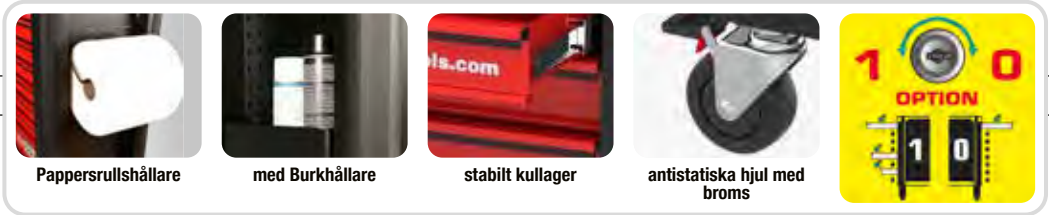

P₁₅

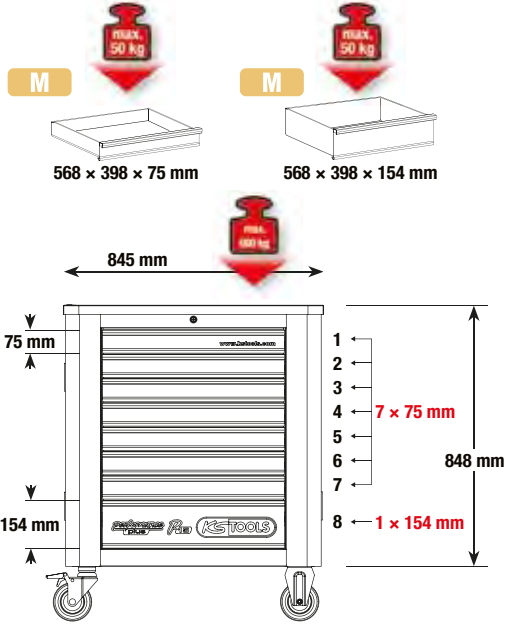

815.7397

DET PERFEKTA PAKETET MED 397 DELAR

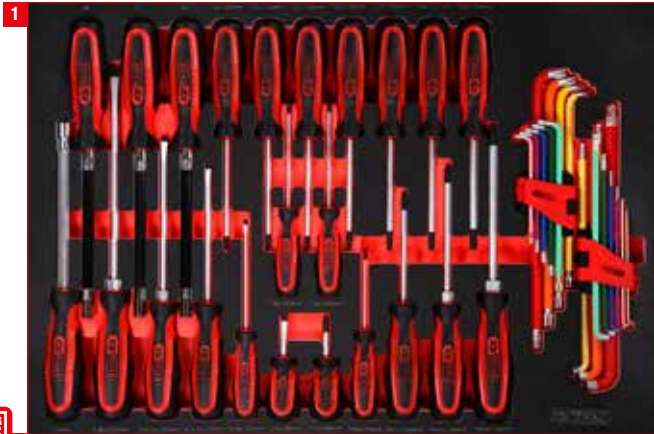

41 Skruvmejsel-sats



41 Skruvnyckelsats

37250,-

810.7397 P10 verktygsvagn med 397 verktyg



111 1/4" + 3/8" + 1/2" insticksnyckel-sats

38630,-

815.7397 P15 verktygsvagn med 397 verktyg



28 Tång- och filset



43 Servicesats för olja och däck



111 1/2" bits sockelsats

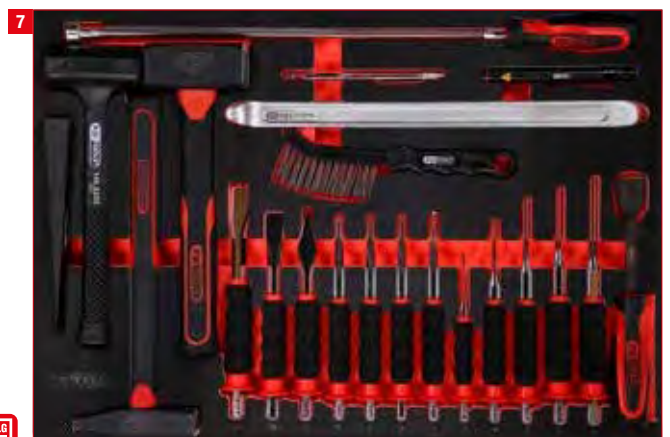

22 Hammar- och mejselsats

HJÄRTLIGT VÄLKOMMEN TILL



Mer information



**MED 564
VERKTYG**

52430,-



integrerat kantskydd



med Burkhållare



stabilt kullager



antistatiska hjul med broms



lås som kan låsas

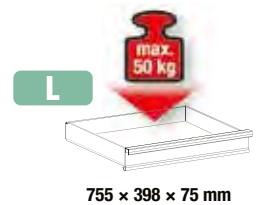
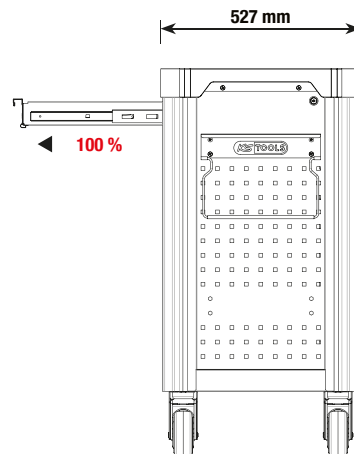
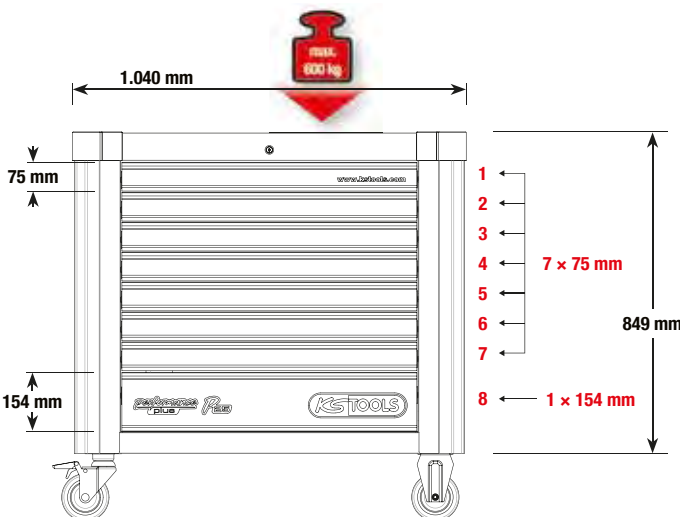

825.8564



DEN HÖGSTA KLASSEN!

Performance
plus

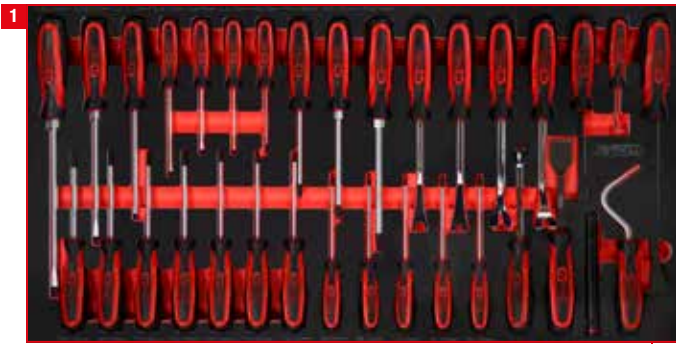

Skruvmejsel-sats

33



1/4" + 3/8" insticksnyckel-sats

213



1/2" insticksnyckel-sats

86



Skruvnyckelsats

57



Skruvnyckelsats

54

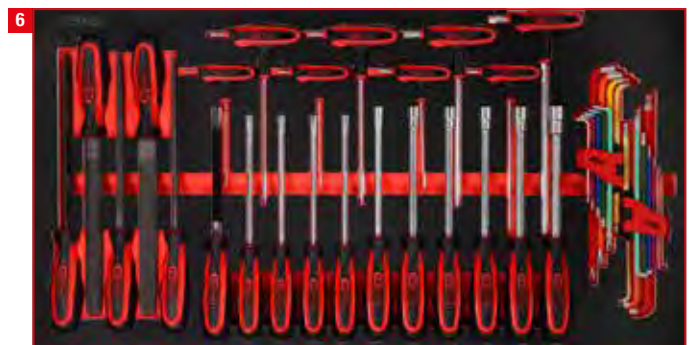

Skruvmejsel- och filset

42

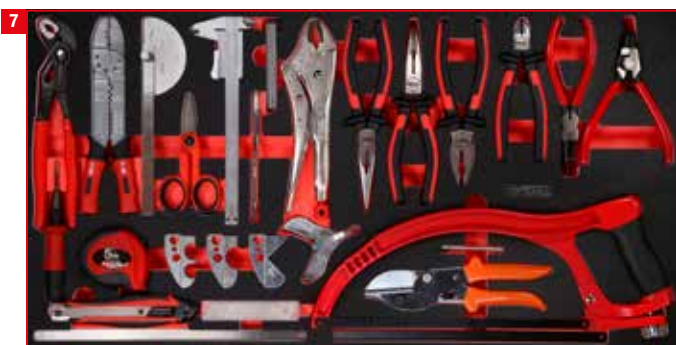

Tång- och mätverktyg-sats

39



Hammar-, mejsel- och kraftuttagsats

40

HUR MÅNGA BILAR KAN DET VARA?



Arbetsplatta med 10 mm tjockt skumplastinlägg



låsbar genom inbyggt cylinderlås



med självindrag och SOFT-CLOSE-funktion



Fyrkantöppning för tillbehör



2 x rullbromsar och rotationsbromsar
Ø hjul: 125 mm

i **1** 897.0007
Mer information

ECO Line

6210,-

UTAN VERKTYG



| Tekniska data: | Eco Line 897.0007 | Racing Line 826.0007 |
|---------------------------------------|-------------------|----------------------|
| Total dragkraft: | 300,0 kg | 350,0 kg |
| Lastkapacitet på varje låda: | 25,0 kg | 30,0 kg |
| självindrag och SOFT-CLOSE-funktion: | ✓ | ✗ |
| hjul diameter: | 125,0 mm | 125,0 mm |
| Ljullås: | ✓ | ✓ |
| Med central förregling: | ✓ | ✓ |
| enskilt lås: | ✗ | ✓ |
| Höjd: | 1014,0 mm | 976,0 mm |
| Bredd: | 748 mm | 788 mm |
| Djup: | 459,0 mm | 496,0 mm |
| Innermått låda: | 565 x 395 mm | 565 x 395 mm |
| med polyuretan i hörn- och kantskydd: | ✗ | ✓ |
| Fyrkantöppning för tillbehör: | ✓ | ✓ |
| Antal lådor: | 7 | 7 |
| plåtjocklek: | 0,8 mm | 0,9 mm |
| handtag: | ✓ | ✓ |
| Expansionsbeslag för låda: | 100 % | 90 % |
| arbetsplatta med fack för smådelar: | ✗ | ✓ |
| Bänkskiva med skuminlägg: | ✓ | ✗ |
| Lådstyrmning med kullager: | ✓ | ✓ |
| med metallhandtag på sidan: | ✓ | ✓ |

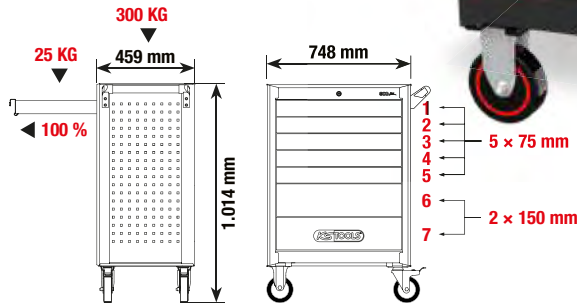

BORTSKÄMD MED VALMÖJLIGHETER? VAL MED KVALITET!

RACING Line



Arbetskiva av ABS med fack för smådelar



låsbar genom inbyggt cylinderlås



Separat låsning förhindrar oönskad öppning



Fyrkantöppning för tillbehör



2 x rullbromsar och rotationsbromsar
Ø hjul: 125 mm

i **1** 826.0007
Mer information

6900,-

UTAN VERKTYG

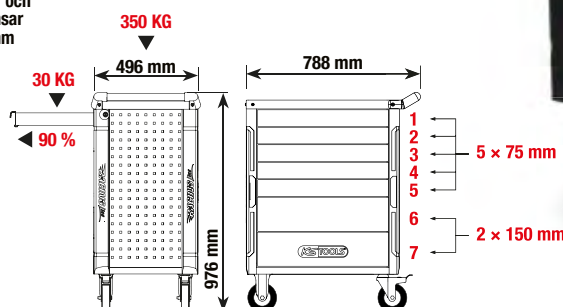

ECO *line*

Med sju lådor och
215-delars premiumverktyg

9390,-

897.7215



STARTPAKET - 215 DELAR

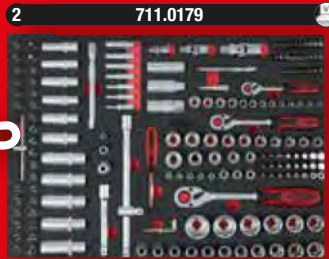

Mer information

RACING *line*

Med sju lådor och
215-delars premiumverktyg

9660,-

826.7215



UNIVERSALPAKET - 515 DELAR

ECO *line*

Med sju lådor och
515-delars premiumverktyg

12150,-

897.7515

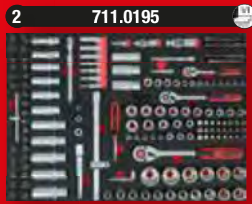
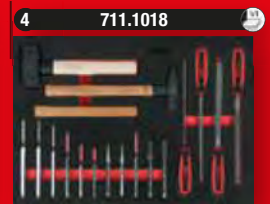
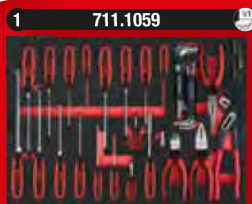

Mer information

RACING *line*

Med sju lådor och
515-delars premiumverktyg

12420,-

826.7515



ECO *line*

Med sju lådor och
598-delars premiumverktyg

17930,-

897.7598

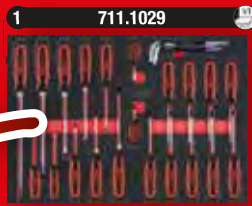

KRAFTPAKET - 598 DELAR

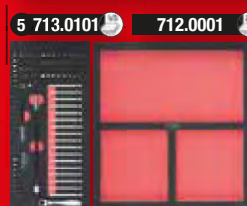
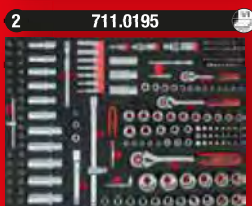

Mer information

RACING *line*

Med sju lådor och
598-delars premiumverktyg

18620,-

826.7598



- DIN 3110 Form B / ISO 10102 / ISO 3318
- U-läge 15° arbetsvinkel
- slipade huvuden
- Matt satinerat
- Krom vanadium

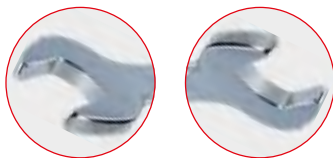

från **280,-**

| | | | | | |
|----------|----------|--|--|---|-----------|
| A | 517.0148 | | | 6x7 · 8x9 · 10x11 · 12x13 14x15 · 16x17 · 18x19 20x22 mm | 280,- SEK |
| B | 517.0123 | | | 6x7 · 8x9 · 10x11 · 12x13 14x15 · 16x17 · 18x19 20x22 · 21x23 · 24x27 30x32 mm | 620,- SEK |
| C | 517.0125 | | | 6x7 · 8x9 · 10x11 · 12x13 14x15 · 16x17 · 18x19 20x22 · 21x23 · 24x27 25x28 · 30x32 mm | 690,- SEK |



- FlankTraction-profil
- U-läge 15° arbetsvinkel
- Ring 15° vinklad
- Polerade huvuden
- Matt satinerat



från **320,-**

| | | | | | |
|----------|----------|--|--|--|------------|
| A | 517.0048 | | | 8 · 9 · 10 · 11 · 13 · 14 17 · 19 mm | 320,- SEK |
| B | 517.0052 | | | 8 · 9 · 10 · 11 · 12 · 13 · 14 15 · 16 · 17 · 18 · 19 mm | 600,- SEK |
| C | 517.0043 | | | 6 · 7 · 8 · 9 · 10 · 11 · 12 13 · 14 · 15 · 16 · 17 · 18 19 · 20 · 21 · 22 · 24 · 27 30 · 32 mm | 1520,- SEK |



- 12-kant
- DIN 838 / ISO 1085 / ISO 10104 / ISO 3318
- Ringar böjda 75°
- tunnväggig
- Polerade huvuden



från **350,-**

| | | | | | |
|----------|----------|--|--|---|-----------|
| A | 517.0248 | | | 6x7 · 8x9 · 10x11 · 12x13 14x15 · 16x17 · 18x19 20x22 mm | 350,- SEK |
| B | 517.0222 | | | 6x7 · 8x9 · 10x11 · 12x13 14x15 · 16x17 · 18x19 20x22 · 21x23 · 24x27 30x32 mm | 690,- SEK |



i **1**
Mer information

210,-

315 mm

22 mm

19 mm

522.1922

i **1**
Mer information

VÄNDBAR 4-I-1-SPÄRRHÅKE

10 mm

13 mm

17 mm

19 mm

280,-

72°

5°

503.4565

10 x 13 x 17 x 19 mm

i **1**
Mer information

MULTITALENTET

Enhands-flerfunktions-nyckel

260 mm

8-17 mm

14-32 mm

114.0055

8 · 9 · 10 · 11 · 12 · 13 · 14 · 15 · 16 · 17 · 18 · 19 · 20 · 21 · 22 · 23 · 24 · 25 · 26 · 27 · 28 · 29 · 30 · 31 · 32 mm

470,-

i **12**
Mer information

72°

5°

1660,-

503.4665

8 · 9 · 10 · 11 · 12 · 13 · 14 · 15 · 16 · 17 · 18 · 19 mm

i **30**
Mer information

DEN MÅNGSIDIGA

5/16" x 13 mm

1/2"

10 mm x 13 mm

3/8"

1/4" x 10 mm

1/4"

12 x

2340,-

503.4960

8 · 9 · 10 · 11 · 12 · 13 · 14 · 15 · 16 · 17 · 18 · 19 mm

i **2**
Mer information

72 5°

1/2"

305 - 445 mm

173 - 223 mm

1/4"

NY

490,-

**JUSTERBART:
1/4" | 4 STEG
1/2" | 6 STEG**

914.1412

i **1**
Mer information

NY

600 MM!

460 - 600 mm

72 5°

1/2"

Steg: 1 2 3 4 5 6

350,-

JUSTERBAR | 6 STEG

914.1205

i **1**
Mer information

690,-

760 mm

1/2"

**MAXIMAL FLEXIBILITET,
OPTIMAL KONTROLL**

918.1293

72 5°

**BESTÄNDIG KRAFT -
INNOVATIV FUNKTION**

A

B

C

1/4"

3/8"

1/2"

från 350,-

| | | | Nm | ↔ | |
|----------|----------|--|------|-----|------------------|
| A | 920.1490 | | 1/4" | 102 | 140 mm 350,- SEK |
| B | 920.3890 | | 3/8" | 325 | 190 mm 420,- SEK |
| C | 920.1290 | | 1/2" | 710 | 245 mm 510,- SEK |

102 Nm

710 Nm

72 5°

760,-

920.0002 **i** **2**
Mer information

DET BÄSTA VI NÅGONSIN KONSTRUERAT!

Vi vet vad vi kan. Och eftersom vi vet exakt hur bra vårt nya sortiment av Monster-spärnycklar är, är det självklart att vi ger dig en garanti på varje modell. Inte 2 eller 3 år. Nej, det är 10 år! Så att garantin är lika premium som våra Monster-spärnycklar!



1 **80°** **420,-** **1/4"** **Mer information**

935.1490 **1/4"** **106 g** **125 mm** **>110 Nm**



2 **80°** **420,-** **1/4"** **Mer information**

935.1495 **1/4"** **106 g** **125 mm** **>100 Nm**

3 **96°** **560,-** **3/8"** **Mer information**

935.3890 **3/8"** **227 g** **199 mm** **>365 Nm**



**GARANTERAT:
6 MONSTER
FÖR LIVET!**

4 **100°** **690,-** **1/2"** **Mer information**

935.1290 **1/2"** **567 g** **275 mm** **>950 Nm**

5 **100°** **970,-** **1/2"** **Mer information**

935.1295 **1/2"** **757 g** **425 mm** **>950 Nm**

6 **100°** **1380,-** **1/2"** **Mer information**

TELESKOPSTÅNG

406 431 457 482 508 533 557 582 607 635 mm **>950 Nm**

935.1285 **1/2"** **1.280 g** **406 - 635 mm**

NY **-15%** **970,-** **>950 Nm** **100°** **1/2"** **+** **80°** **1/4"** **>110 Nm** **Mer information**

935.0002

9 Hylsbitssats för Insexskruv, kort

Mer information

3/8"

4 mm 5 mm 6 mm 7 mm 8 mm 9 mm 10 mm 12 mm 14 mm

Extra kort modell ✓

50 mm

28 mm

NY

490,-

917.4000 4 - 5 - 6 - 7 - 8 - 9 - 10 - 12 - 14 mm

10 Hylsbitssats för Torxskruv, kort

Mer information

3/8"

T10 T15 T20 T25 T27 T30 T40 T45 T50 T55

Extra kort modell ✓

50 mm

28 mm

NY

560,-

917.4015 T10 - T15 - T20 - T25 - T27 - T30 - T40 - T45 - T50 - T55

77 TORX TOTAL: ALLT I EN VÄSKA

Mer information

| | | |
|-----|------|--|
| 5 x | 1/4" | E4 - E5 - E6 - E7 - E8 |
| 4 x | 3/8" | E10 - E12 - E14 - E16 |
| 4 x | 1/2" | E18 - E20 - E22 - E24 |
| 5 x | 1/4" | EPL4 - EPL5 - EPL6 - EPL7 - EPL8 |
| 4 x | 3/8" | EPL10 - EPL12 - EPL14 - EPL16 |
| 4 x | 1/2" | EPL18 - EPL20 - EPL22 - EPL24 |
| 8 x | 1/4" | T6 - T8 - T10 - T15 - T20 - T25 - T27 - T30 |
| 5 x | 3/8" | T40 - T45 - T47 - T50 - T55 |
| 2 x | 1/2" | T60 - T70 |
| 7 x | 1/4" | TB8 - TB10 - TB15 - TB20 - TB25 - TB27 - TB30 |
| 4 x | 3/8" | TB40 - TB45 - T50 - T55 |
| 1 x | 1/2" | TB60 |
| 7 x | 1/4" | IP8 - IP10 - IP15 - IP20 - IP25 - IP27 - IP30 |
| 3 x | 3/8" | IP40 - IP45 - IP50 |
| 2 x | 1/2" | IP55 - IP60 |
| 7 x | 1/4" | IPR8 - IPR10 - IPR15 - IPR20 - IPR25 - IPR27 - IPR30 |
| 3 x | 3/8" | IPR40 - IPR45 - IPR50 |
| 2 x | 1/2" | IPR55 - IPR60 |

E ✓

EPL ✓

TX ✓

TB ✓

IP ✓

IPR ✓

1380,-

NY

EVOLUTION SERIES

1/4" + 3/8" + 1/2"

911.0077

STAINLESS STEEL

i **30**
Mer information

EVOLUTION SERIES

NY

1110,-

1/2"

911.4510

STAINLESS STEEL

| | | |
|--------|---|---|
| 55 mm | ● | 5 - 6 - 7 - 8 - 10 - 12 - 14 - 17 - 19 mm |
| 100 mm | ● | 5 - 6 - 7 - 8 - 10 - 11 - 12 - 13 mm |
| 140 mm | ● | 5 - 6 - 7 - 8 - 10 - 12 - 14 mm |
| 200 mm | ● | 5 - 6 - 7 - 8 - 10 - 12 mm |

i **32**
Mer information

EVOLUTION SERIES

NY

1110,-

1/2"

911.4520

STAINLESS STEEL

| | | |
|--------|---|--|
| 55 mm | ★ | M5 - M6 - M7 - M8 - M9 - M10 - M12 - M13 - M14 |
| 100 mm | ★ | M5 - M6 - M7 - M8 - M9 - M10 - M12 - M13 - M14 |
| 140 mm | ★ | M7 - M8 - M9 - M10 - M12 - M13 - M14 |
| 200 mm | ★ | M7 - M8 - M9 - M10 - M12 - M13 - M14 |

i **26**
Mer information

EVOLUTION SERIES

NY

1110,-

1/2"

911.4540

STAINLESS STEEL

| | | |
|--------|---|---|
| 55 mm | ● | M5 - M6 - M8 - M9 - M10 - M12 - M14 - M16 |
| 100 mm | ● | M5 - M6 - M8 - M9 - M10 - M12 - M14 |
| 140 mm | ● | M5 - M6 - M8 - M9 - M10 - M12 - M14 |
| 200 mm | ● | M8 - M10 - M12 - M14 |

i **32**
Mer information

EVOLUTION SERIES

NY

1110,-

1/2"

911.4550

STAINLESS STEEL

| | | |
|--------|---|---|
| 55 mm | ★ | T20 - T25 - T27 - T30 - T40 - T45 - T50 - T55 - T60 - T70 |
| 100 mm | ★ | T20 - T25 - T27 - T30 - T40 - T45 - T50 - T55 - T60 - T70 |
| 140 mm | ★ | T40 - T45 - T50 - T55 - T60 - T70 |
| 200 mm | ★ | T40 - T45 - T50 - T55 - T60 - T70 |

A Matt satinerat **B** Kromad och blankpolerad

från 390,-

A 917.0648 48 390,- SEK $\frac{1}{4}$ "

B 918.0648 48 420,- SEK

4 - 4,5 - 5 - 5,5 - 6 - 7 - 8 - 9
10 - 11 - 12 - 13 - 14 mm

i 20 Mer information

Matt satinerat

830,-

$\frac{1}{2}$ "

10 - 11 - 12 - 13 - 14 - 15 - 16
17 - 18 - 19 - 20 - 21 - 22 - 24
27 - 30 - 32 mm

911.0620

A Matt satinerat **B** Kromad och blankpolerad

från 1110,-

A 911.0694 94 1110,- SEK $\frac{1}{4}$ " + $\frac{1}{2}$ "

B 918.0694 94 1250,- SEK

4 - 4,5 - 5 - 5,5 - 6 - 7 - 8 - 9
10 - 11 - 12 - 13 - 14 - 15 - 16
17 - 18 - 19 - 20 - 21 - 22 - 23
24 - 27 - 30 - 32 mm

i 108 Mer information

Matt satinerat

1250,-

$\frac{1}{4}$ " + $\frac{1}{2}$ "

4 - 4,5 - 5 - 5,5 - 6 - 7 - 8 - 9
10 - 11 - 12 - 13 - 14 - 15 - 16
17 - 18 - 19 - 20 - 21 - 22 - 24
27 - 30 - 32 mm

911.0708



179

Mer information

| | |
|-------------|--|
| 1/4" | 4 - 4,5 - 5 - 5,5 - 6 - 7 - 8 - 9 - 10 - 11 - 12 13 - 14 mm |
| 1/4" | 4 - 5 - 6 - 7 - 8 - 9 - 10 mm |
| | E4 - E5 - E6 - E7 - E8 |
| | ⊖ ⊕ ⊗ ⊛ ⊚ ⊛ ⊚ |
| 3/8" | 10 - 11 - 12 - 13 - 14 - 15 - 16 - 17 - 18 19 mm |
| 3/8" | 10 - 11 - 12 - 13 - 14 - 15 mm |
| | E10 - E11 - E12 - E14 - E16 - E1 |
| 1/2" | 10 - 11 - 12 - 13 - 14 - 15 - 16 - 17 - 18 19 - 20 - 21 - 22 - 24 - 27 - 30 - 32 mm |
| 1/2" | 16 - 17 - 18 - 19 - 22 mm |
| | E20 - E24 |
| 1/4" | ⊖ ⊕ ⊗ ⊛ ⊚ ⊛ ⊚ |
| 5/16" | ⊖ ⊕ ⊗ ⊛ ⊚ ⊛ ⊚ |
| 1/4" - 3/8" | 50 - 100 - 125 - 150 - 250 mm |
| 1/2" | 1,3 - 1,5 - 2 - 2,5 - 3 - 4 - 5 mm |
| 1/4" - 3/8" | |
| 1/2" | |
| 1/4" - 3/8" | 1/4" - 5/16" |
| 1/4" | |



1/4" + 3/8" + 1/2"

Förnicklad

Matt satinerat

1310,-

917.0779



| | |
|-------------|---|
| 1/4" | 4 - 4,5 - 5 - 5,5 - 6 - 7 - 8 - 9 - 10 - 11 12 - 13 - 14 mm |
| 1/4" | 6 - 7 - 8 - 9 - 10 - 11 - 12 - 13 - 14 15 mm |
| | ⊖ ⊕ ⊗ ⊛ ⊚ ⊛ ⊚ |
| 3/8" | 10 - 11 - 12 - 13 - 14 - 15 - 16 - 17 - 18 19 mm |
| 3/8" | 10 - 11 - 12 - 13 - 14 - 15 mm |
| | ⊖ ⊕ ⊗ ⊛ ⊚ ⊛ ⊚ |
| 1/2" | 10 - 11 - 12 - 13 - 14 - 15 - 17 - 18 - 19 20 - 21 - 22 - 24 - 27 - 30 - 32 mm |
| 1/2" | 17 - 19 - 22 mm |
| | ⊕ |
| 1/4" | ⊖ ⊕ ⊗ ⊛ ⊚ ⊛ ⊚ |
| 5/16" | ⊖ ⊕ ⊗ ⊛ ⊚ ⊛ ⊚ |
| 12 x | 8 - 9 - 10 - 11 - 12 - 13 - 14 - 15 - 16 17 - 18 - 19 mm |
| | 1,3 - 1,5 - 2 - 2,5 - 3 - 4 - 5 mm |
| 1/4" - 3/8" | |
| 1/2" | |
| 1/4" | |

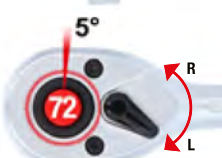

A Matt satinerat

B Kromad och blankpolerad

från 2420,-

A 917.0216



216

2420,- SEK

Förnicklad

B 918.0216



216

2630,- SEK

1/4" + 3/8" + 1/2"

| | | | | | | | |
|----------|----------|--|--|----|--|---|------------|
| A | 911.0721 | | | 21 | | 19 · 21 · 22 · 23 · 24 · 26 · 27 · 29 · 30 32 · 35 · 36 · 38 · 41 · 46 · 50 mm | 3040,- SEK |
| B | 911.0722 | | | 21 | | 19 · 21 · 22 · 23 · 24 · 26 · 27 · 29 · 30 32 · 35 · 36 · 38 · 41 · 46 · 50 mm | 3430,- SEK |
| C | 911.0751 | | | 21 | | 3/4" · 13/16" · 7/8" · 15/16" · 1" 1.1/16" · 1.1/8" · 1.3/16" · 1.1/4" 1.5/16 · 1.3/8" · 1.7/16" · 1.1/2" 1.5/8" · 1.3/4" · 2" | 3430,- SEK |

från
3040,-

| | | | |
|------------------------|--|--|----|
| | | | 82 |
| Mer information | | | |
| 1/4" | | 4 - 4,5 - 5 - 5,5 - 6 - 7 - 8 - 9 - 10 - 11 12 - 13 - 14 mm | |
| 1/2" | | 14 - 15 - 16 - 17 - 18 - 19 - 20 - 21 - 22 24 - 27 - 30 - 32 mm | |
| 1/4" | | 16 - 21 mm | |
| 1/4" | | | |
| 5/16" | | | |
| 1/4" | | | |
| 1/2" | | | |
| 1/4" | | 150 mm | |
| 1/4" | | 50 - 100 - 125 - 250 mm | |
| 1/2" | | | |
| 1/4" | | 150 mm | |
| 12 x | | 8 - 10 - 11 - 12 - 13 - 14 - 17 - 19 - 22 mm | |

1800,-

1/4" + 1/2"

Matt satinerat

Förnicklad

i  **47**
Mer information

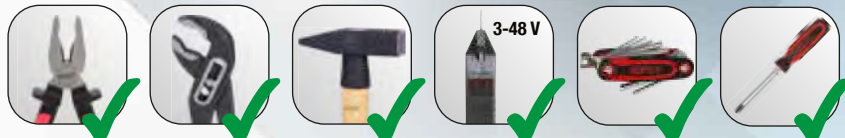

| | | |
|------|---|---|
| 1/2" |  | 10 - 11 - 12 - 13 - 14 - 15 - 16 - 17 18 - 19 - 20 - 21 - 22 - 24 mm |
| 3 x |  | 16 - 18 - 21 mm |
| 14 x |  | 6 - 7 - 8 - 9 - 10 - 11 - 12 - 13 - 14 15 - 16 - 17 - 18 - 19 mm |
| 1 x |  | 250 mm |
| 2 x |  | 125 - 250 mm |
| 1 x |  | 1/2" |
| 5 x |  | 3 - 5,5 - 8 mm + PH1 - PH2 |
| 1 x |  | T8 - T10 - T15 - T20 - T25 - T27 T30 - T40 |
| 1 x |  | 2,5 - 3 - 4 - 5 - 6 - 7 - 8 - 10 mm |
| 1 x |  | 3 - 48 V |
| 1 x |  | 240 mm |
| 1 x |  | 180 mm |
| 1 x |  | 300 g |















Matt satinerat

2070,-

1/2"

940.0047



| | | |
|------|---|---|
| 1/4" |  | 4 - 4,5 - 5 - 5,5 - 6 - 7 - 8 - 9 - 10 11 - 12 - 13 mm |
| 1/2" |  | 10 - 11 - 12 - 13 - 14 - 15 - 16 - 17 19 - 20 - 21 - 22 - 24 - 27 - 30 - 32 mm |
| 12 x |  | 8 - 9 - 10 - 11 - 12 - 13 - 14 - 15 - 16 17 - 18 - 19 mm |
| 2 x |  | 1/4": 100 mm / 1/2": 125 mm |
| 1 x |  | 1/4" / 1/2" |
| 7 x |  | 3 - 4 - 5,5 - 6,5 mm + PH0 - PH1 - PH2 |
| 1 x |  | T8 - T10 - T15 - T20 - T25 - T27 - T30 T40 - T45 - T50 |
| 1 x |  | 1,5 - 2 - 2,5 - 3 - 4 - 5 - 6 - 8 - 10 mm |
| 1 x |  | |
| 1 x |  | 300 g |
| 1 x |  | 160 mm |
| 1 x |  | 200 mm |



B

1/4" + 1/2"

A Matt satinerat

B Kromad och blankpolerad

A 917.0797



97 2420,- SEK

B 918.0797



97 2630,- SEK



Förnicklad

A

från
2420,-

i **88**
Mer information

150-250 V

| | |
|------|--|
| 1/4" | 4 - 4,5 - 5 - 5,5 - 6 - 7 - 8 - 9 - 10 - 11 12 - 13 mm |
| 1/2" | 14 - 15 - 16 - 17 - 18 - 19 - 20 - 21 - 22 23 - 24 - 25 - 26 - 27 - 28 30 - 32 mm |
| 12 x | 6 - 7 - 8 - 9 - 10 - 11 - 12 - 13 - 14 17 - 19 - 22 mm |
| 3 x | 1/4": 50 - 100 mm / 1/2": 125 mm |
| 1 x | 1/4" |
| 4 x | ⊖ 6,5 - 8 mm ⊕ PH1 - PH2 |
| 1 x | 1/4" |
| 1 x | 1/4" ⊖ ⊕ * ● ☆ |
| 1 x | 150 - 250 V |
| 1 x | 250 mm |
| 1 x | 180 mm |
| 1 x | 300 g |

2630,-

Matt satinerat

911.0688

1/4"
+ 1/2"

i **127**
Mer information

DEN MÅNGSIDIGA

1

4 x

⊖ ⊕

2

8 x

8 - 9 - 10 - 11 - 13
14 - 17 - 19 mm

3

4

4

5110,-

911.0727

1/4"
+ 1/2"



Mer information



6 x



| | | |
|------|--|--|
| 1/4" | | 4 - 4,5 - 5 - 5,5 - 6 - 7 8 - 9 - 10 - 11 - 12 13 mm |
| 1/2" | | 10 - 13 - 14 - 15 - 16 17 - 18 - 19 - 21 - 22 24 - 27 - 30 - 32 mm |
| 10 x | | 8 - 10 - 11 - 12 - 13 14 - 15 - 17 - 19 - 22 mm |



5390,-

911.0649

1/4" + 1/2"

**ETT KOMPLETT SET?
SLÅ TILL HÄR!**



Mer information



6 x

3 x



| | | |
|-----|--|--|
| 9 x | | 1,5 - 2 - 2,5 - 3 - 4 - 5 - 6 8 - 10 mm |
| 9 x | | TS10 - TS15 - TS20 - TS25 TS27 - TS30 - TS40 - TS45 TS50 |



| | | |
|------|--|---|
| 1/4" | | 4 - 4,5 - 5 - 5,5 - 6 - 7 8 - 9 - 10 - 11 - 12 13 mm |
| 1/2" | | 10 - 11 - 12 - 13 - 14 15 - 16 - 17 - 18 - 19 21 - 22 - 24 - 27 - 30 32 mm |
| 11 x | | 8 - 9 - 10 - 11 - 12 13 - 14 - 16 - 17 - 19 22 mm |



6210,-

911.0630

1/4" + 1/2"

FÖR ELEKTRIKER

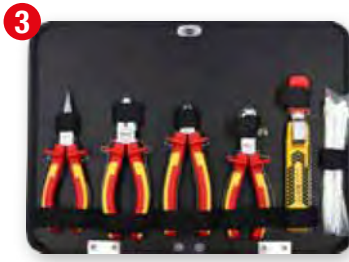

4 x

1/4" 4 - 4,5 - 5 - 5,5 - 6 - 7 - 8
9 - 10 - 11 - 12 - 13 mm

1/2" 10 - 11 - 12 - 13 - 14 - 15
16 - 17 - 18 - 19 - 21 - 22 mm

10 x 8 - 10 - 11 - 12 - 13 - 14
15 - 17 - 19 - 22 mm

1/4" + 1/2"

911.0628

5390,-

ALLROUNDERN

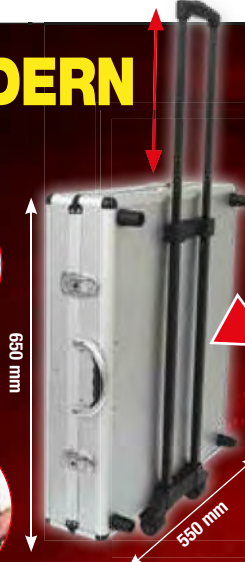

1/4" 4 - 5 - 6 - 7 - 8 - 9 - 11
12 - 13 mm

1/2" 10 - 11 - 12 - 13 - 14 - 15 - 16
17 - 18 - 19 - 21 - 22 - 24 mm

10 x 8 - 9 - 10 - 11 - 12 - 13
14 - 16 - 17 - 18 - 19 mm

1/4" + 1/2"

911.0735

7180,-



99

Mer information

SKATTKISTORNA!



99

Mer information



2

SPÄRRINGNYCKEL

8 - 9 - 10 - 11 - 12 - 13 - 14 - 15 - 16 - 17 - 18 - 19 mm

| | |
|------|---|
| 1/4" | 4 - 5 - 6 - 7 - 8 - 9 - 10 - 11 - 12 13 - 14 mm |
| 1/2" | 13 - 15 - 17 - 18 - 19 - 20 - 21 - 22 24 - 27 - 30 - 32 mm |



1

DU KAN VÄLJA!



2

RINGGAPSNYCKEL

8 - 9 - 10 - 11 - 12 - 13 - 14 - 15 - 16 - 17 - 18 - 19 mm



5°

R

L

1

2

3

4



3



4



5°

R

L

1

2

3

4

8280,-

1/4" 1/2"



7180,-

1/4" 1/2"

918.0100



918.0200



40

Mer information



1/2"



9

10

11

12

13

14

15

16

17

18

19

20

21

22

23

24

26

27

30 mm



9

10

11

12

13

14

15

16

17

18

19

20

21

22

23

24

26

27

30 mm



125 mm

45°

360°



1590,-

515.0065

1/2"





1
Mer information





från
1380,-





Skala med lupp



Mikrometerskala



Mit skattering i konformitetsförklaring
DIN EN ISO 6799
Certifikat
Noggrannhet ±0,5%

| | | Nm | Delning Nm | Lbf-ft | | |
|----------|--|------|------------|--------|-----------|------------|
| 516.1402 | | 1/4" | 1-5 | 0,10 | 0,8 - 3,6 | 1380,- SEK |
| 516.1412 | | 1/4" | 5-25 | 0,10 | 0,8 - 18 | 1380,- SEK |
| 516.1422 | | 3/8" | 10-50 | 0,25 | 4 - 37 | 1380,- SEK |
| 516.1432 | | 1/2" | 20-100 | 0,50 | 8 - 75 | 1540,- SEK |
| 516.1442 | | 1/2" | 40-200 | 1,00 | 15 - 150 | 1540,- SEK |
| 516.1472 | | 1/2" | 60-320 | 1,00 | 45 - 236 | 1730,- SEK |
| 516.1482 | | 1/2" | 80-420 | 1,00 | 60 - 310 | 1880,- SEK |
| 516.1493 | | 3/4" | 150-750 | 10,00 | 150 - 550 | 8130,- SEK |
| 516.1495 | | 1" | 200-1000 | 20,00 | 220 - 730 | 9300,- SEK |





1
Mer information

3 | 1



LÅNG

140,-

| | | | | | | |
|---|----------|--|--|---|--|-----------|
| A | 151.2100 | | | 8 | 2 - 2,5 - 3 - 4 - 5 - 6 8 - 10 mm | 140,- SEK |
| B | 151.2300 | | | 8 | T10 - T15 - T20 - T25 T30 - T40 - T45 - T50 | 140,- SEK |





22
Mer information



LÅNG

180,-

| | | | | | | |
|---|----------|--|--|----|--|-----------|
| A | 151.4000 | | | 22 | 1,27 - 1,5 - 2 - 2,5 - 3 - 3,5 - 4 - 4,5 - 5 - 6 - 7 - 8 - 10 mm | 180,- SEK |
| B | | | | | T10 - T15 - T20 - T25 - T27 - T30 T40 - T45 - T50 | |

DE 22 VIKTIGASTE
I EN UPPSÄTTNING

i **32**
Mer information

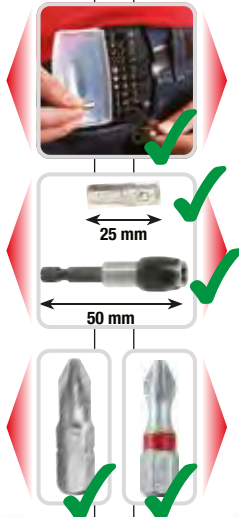

i **32**
Mer information

TORION power



- 1 x 1/4"
- 1 x 1/4"
- 3 x PH1 - PH2 - PH3
- 6 x 2 x PZ1 - 2 x PZ2 - 2 x PZ3
- 3 x 5,5 - 6,5 - 8 mm
- 3 x 4 - 5 - 6 mm
- 15 x 2 x TB10 - 3 x TB15 - 2 x TB20
3 x TB25 - 3 x TB30 - 2 x TB40

911.2060

130,-

911.3030

140,-

- 1 x 1/4"
- 1 x 1/4"
- 4 x 3 - 4 - 5 - 6 mm
- 4 x PH1 - 2 x PH2 - PH3
- 4 x PZ1 - 2 x PZ2 - PZ3
- 4 x 3 - 4 - 5 - 6 mm
- 7 x T10 - T15 - T20 - T25 - T27 - T30 - T40
- 7 x TB10 - TB15 - TB20 - TB25 - TB27 - TB30 - TB40

i **108**
Mer information

TORION power

- 25 mm 6x: 4 - 5 - 6 mm
- 6x: 4 - 5 - 6 mm
- 6x: PH1 - PH2 - PH3
- 6x: PZ1 - PZ2 - PZ3
- 6x: T10 - T15 - T20 - T25 - T30 - T40

420,-



918.3108

1/4"

108 BITS SOM GÖR SKILLNAD

i **32**
Mer information



- 4 x 3 - 4 - 5 - 6 mm
- 4 x PH1 - 2 x PH2 - PH3
- 4 x PZ1 - 2 x PZ2 - PZ3
- 4 x 3 - 4 - 5 - 6 mm
- 7 x T10 - T15 - T20 - T25
T27 - T30 - T40
- 7 x TB10 - TB15 - TB20 - TB25
TB27 - TB30 - TB40

918.3010

1/4"

620,-



i **31**
Mer information



TORION power



- 2 x 4 - 5 mm
- 3 x PH1 - PH2 - PH3
- 3 x PZ1 - PZ2 - PZ3
- 9 x 1,5 - 2 - 2,5 - 3 - 4 - 5 - 6
7 - 8 mm
- 11 x T6 - T7 - T8 - T9 - T10 - T15
T20 - T25 - T27 - T30 - T40

918.3015

1/4"

800,-



i **24**
Mer information

LITEN OCH BEHÄNDIG

25 mm
Förmicklad

280,-

| | | |
|-----|--|----------------------------------|
| 1 x | | 1/4": 92 mm |
| 1 x | | 1/4": 50 mm |
| 1 x | | 1/4" |
| 6 x | | 6 - 7 - 8 - 10 - 11 - 13 mm |
| 2 x | | PH1 - PH2 |
| 2 x | | PZ1 - PZ2 |
| 2 x | | 4,5 - 5,5 mm |
| 4 x | | 3 - 4 - 5 - 6 mm |
| 5 x | | TB10 - TB15 - TB20 - TB25 - TB30 |

911.2010 **1/4"**

i **208**
Mer information

560,-

UNIVERSALSKRUVMEJSEL!

| | | |
|-------|--|--|
| 1/4" | | 1/4": 205 mm |
| 138 x | | 25 mm |
| 29 x | | 50 mm |
| 18 x | | 75 mm |
| 20 x | | 4 - 5 - 6 - 7 - 8 - 9 - 10 - 11 - 12 - 13 mm 5/32" - 3/16" - 7/32" - 1/4" - 9/32" 5/16" - 11/32" - 3/8" - 7/16" - 1/2" |
| 1 x | | 1/4": 50 mm |
| 1 x | | 1/4" |

911.2008 **1/4"**

i **7**
Mer information

DET LILLA TEKNIKUNDRET!

140,-

6 IN ONE

110 mm

NY

- 4 - 5 mm
- PH1 - PH2
- PZ1 - PZ2

911.2025 **1/4"**

6 i 1 Mini-spärrskruvmejsel

i **13**
Mer information

210,-

12 IN ONE

240 mm

- 4 - 5 - 6 mm
- PH1 - PH2 - PH3
- 3 - 4 - 5 mm
- T15 - T20 - T25

911.2035 **1/4"**

12-i-1 spärr-bits-skruvdragare

1
Mer information

211

ELLER

1/4"

85 mm

130,-

514.1126

1
Mer information

1/4"

160,-

MED LÄNK

90 mm

20°

514.1136

21
Mer information

4 mm

30 mm

165 mm

16 mm

560,-

500.7195

1 - 1,3 - 1,5 - 2 - 2,5 - 3 mm

PH00 - PH0 - PH1 - PH2

1,5 - 2 - 2,5 - 3 - 3,5 mm

T3 - T4 - T5 - T6 - T7

27
Mer information

LED

1/4"

eMONSTER

EN GÅNG RÖRD, FÖR ALLTID FÖRFÖRD.

490,-

515.3600

max 6 Nm

max 4 Nm

max 2 Nm

| | | |
|----|--|--------------------------|
| 4x | | 3,0 - 4,0 - 5,0 - 6,0 mm |
| 4x | | 3,0 - 4,0 - 5,0 - 6,0 mm |
| 5x | | PH0 - PH1 - PH2 - PH3 |
| 4x | | PZ0 - PZ1 - PZ2 - PZ3 |
| 4x | | T10 - T15 - T20 - T25 |
| 4x | | #0 - #1 - #2 - #3 |
| 1x | | PH1 |
| 1x | | 50 mm |
| 1x | | Max. 6 Nm |

3,6 V

1.500 mAh

300 rpm

USB-C

2+ LED



51



Mer information

ALLROUNDERN



1 Borr



2 Rengöring



3 Slipning



23x



4 Gravering

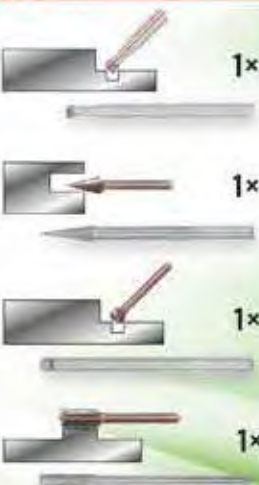

5 Separering



6 Polering



eMONSTER Sladdlös multiverktygssats med 50 tillbehör



eMONSTER



690,-

515.3990



50



Mer information

ATT KÖPA SENARE



Tillbehörssats, 50 delar

140,-

515.3992

TRANSFORMATORN BLAND SKRUVMEJSLARNA



eMONSTER

Hög hastighet på 210 rpm, därför 5 gånger snabbare än manuell åtdragning

praktisk batteriladdningsstatusvisning med 3 lysdioder

förstärkt transmission

magnetisk bitshållare



vidmomentförval justerbart i 10 steg



Överdragning av skruvarna förhindras genom automatisk låsning av motorn när vridmomentet överskrids.

integrerad lampa



förbättrad greppkomfort

1,3 Ah batteri med en drifttid för 1000+ skruvar

Tack vare USB-C-anslutningen laddas det högpresterande Li-ION-batteriet snabbt upp och är redo att användas.



2-i-1-enhet med en bra balans mellan prestanda och storlek, idealisk för arbete över huvudet och i trånga utrymmen.



25 bits ingår



Mer information

560,-

515.6500

ERGOTORQUE^{plus}

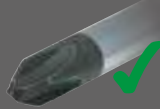

Kromad med polerad spets



med profilmärkning i handtaget

i **5** **159.0005**

Mer information

140,-

PH1 PH2 6,5 mm 5,5 mm 4 mm

i **6** **159.0030**

Mer information

280,-

T10 T15 T20 T25 T30 T40

i **6** **159.0040**

Mer information

280,-

TB10 TB15 TB20 TB25 TB30 TB40

i **39**

Mer information

710,-

| | | | | | |
|-----|--|--------------------------------|-----|--|--|
| 6 x | | 3 - 4 - 5,5 - 6,5 8 - 10 mm | 7 x | | 2 - 2,5 - 3 - 4 - 5 6 - 8 mm |
| 5 x | | PH0 - PH1 - PH2 PH3 - PH4 | 7 x | | TB10 - TB15 - TB20 TB25 - TB27 - TB30 TB40 |
| 4 x | | PZ0 - PZ1 - PZ2 PZ3 | 7 x | | T10 - T15 - T20 T25 - T27 - T30 T40 |
| 1 x | | 6 mm | 1 x | | 1/4" |
| 1 x | | PH2 | 1 x | | 205 mm |

159.0100 **1/4"**

i **13**

Mer information

SLAGTÅLIG!

940,-

Genomgående klinga

| | | |
|-----|--|-----------------------------|
| 5 x | | 3,5 - 5,5 - 7 - 8 - 10 mm |
| 5 x | | PH0 - PH1 - PH2 - PH3 - PH4 |
| 1 x | | 6 mm |
| 1 x | | PH2 |
| 1 x | | 1/4" |

151.1150 **1/4"**

i **15**
Mer information

260 mm

A

940,-

150.9805

| | | A | B |
|--|-----------------------------|-------------------------------------|-------------------------------------|
| | | 150.9805 | 150.9630 |
| | Nitar (aluminium) | <input checked="" type="checkbox"/> | <input checked="" type="checkbox"/> |
| | Nitar (stål) | <input checked="" type="checkbox"/> | <input checked="" type="checkbox"/> |
| | Mutter | <input checked="" type="checkbox"/> | <input checked="" type="checkbox"/> |
| | resväskan | <input checked="" type="checkbox"/> | <input checked="" type="checkbox"/> |
| | längd mm | 260 | 510 |
| | plåtperforatör | <input checked="" type="checkbox"/> | <input checked="" type="checkbox"/> |
| | en- eller tvåhandsoperation | <input checked="" type="checkbox"/> | <input checked="" type="checkbox"/> |
| | M10 | <input checked="" type="checkbox"/> | <input checked="" type="checkbox"/> |
| | M8 | <input checked="" type="checkbox"/> | <input checked="" type="checkbox"/> |
| | M6 | <input checked="" type="checkbox"/> | <input checked="" type="checkbox"/> |
| | M5 | <input checked="" type="checkbox"/> | <input checked="" type="checkbox"/> |
| | M4 | <input checked="" type="checkbox"/> | <input checked="" type="checkbox"/> |
| | M3 | <input checked="" type="checkbox"/> | <input checked="" type="checkbox"/> |
| | Stål 4,8 mm | <input checked="" type="checkbox"/> | <input checked="" type="checkbox"/> |
| | Stål 4,0 mm | <input checked="" type="checkbox"/> | <input checked="" type="checkbox"/> |
| | Stål 3,2 mm | <input checked="" type="checkbox"/> | <input checked="" type="checkbox"/> |
| | Stål 2,4 mm | <input checked="" type="checkbox"/> | <input checked="" type="checkbox"/> |
| | Aluminium 6,4 mm | <input checked="" type="checkbox"/> | <input checked="" type="checkbox"/> |
| | Aluminium 4,8 mm | <input checked="" type="checkbox"/> | <input checked="" type="checkbox"/> |
| | Aluminium 4,0 mm | <input checked="" type="checkbox"/> | <input checked="" type="checkbox"/> |
| | Aluminium 3,2 mm | <input checked="" type="checkbox"/> | <input checked="" type="checkbox"/> |
| | Aluminium 2,4 mm | <input checked="" type="checkbox"/> | <input checked="" type="checkbox"/> |

i **17**
Mer information

510 mm

B

2420,-

150.9630

i  **1**
Mer information



från 160,-

| | ↔ | ↔ | |
|----------|--------|-----|-----------|
| 115.2011 | 175 mm | 7" | 160,- SEK |
| 115.2010 | 240 mm | 10" | 180,- SEK |
| 115.2012 | 300 mm | 12" | 220,- SEK |
| 115.2016 | 415 mm | 16" | 450,- SEK |



i  **4**
Mer information

CrV DIN 5254 A DIN 5254 B DIN 5256 C DIN 5256 D

PREMIUMKVALITET!

i  **4**
Mer information



A 19 - 60 mm



90°

0°

0°

90°



B 40 - 100 mm

från 1540,-

| | ↔ | ↔ | |
|----------|----------|-------------|-------------------|
| A | 119.2055 | 19 - 60 mm | 160 mm 1540,- SEK |
| B | 119.2060 | 40 - 100 mm | 230 mm 1730,- SEK |

i  **20**
Mer information

SAFETY FIRST



60 - 100 mm

40 - 85 mm

690,-

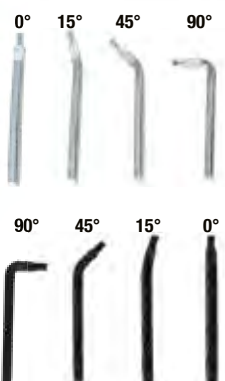

500.1350 Säkringstång-sats med spärrfunktion

SE MIG I ÖGONEN, SNYGGING!

i **10**
Mer information



260 mm

300 mm

| | | |
|-----|--|--------|
| 1 x | | 120 mm |
| 1 x | | 120 mm |
| 1 x | | 120 mm |

| | | |
|-----|--|--------------------|
| 1 x | | 160 mm |
| 3 x | | PH00 - PH0 - PH1 |
| 3 x | | 2,0 - 2,4 - 3,0 mm |

500.7220

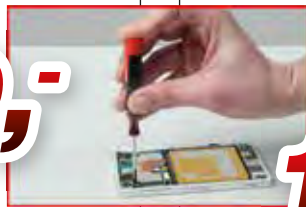

| | | |
|-----|--|--------------|
| 2 x | | 125 - 130 mm |
| 1 x | | 100 mm |
| 1 x | | 100 mm |
| 1 x | | 125 mm |
| 1 x | | 150 mm |
| 1 x | | 145 mm |

500.7190

i **21**
Mer information



430 mm

370 mm

| | | |
|-----|--|-------------------------------------|
| 3 x | | PH00 - PH0 - PH1 |
| 4 x | | 1,4 - 2,0 - 2,4 - 3,0 mm |
| 7 x | | T6 - T7 - T8 - T9 - T10 - T15 - T20 |

i **1**
Mer information



Med stabil, rivnäliknande inställningsspets



90,-

150 - 675 mm

med styvt magnethuvud

550.1001 2 i 1 teleskop-magnethävert med tvättmunstyck-rengörings- och inställningsverktyg

i **1**
Mer information



Med tunn rengöringsstav



110,-

150 - 590 mm

med flexibla magnethuvud

550.1023 2 i 1 teleskop-magnethävert med tvättmunstyck-rengörings- och inställningsverktyg

i **1**
Mer information

140,-

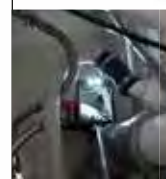

550.1136 Flexibel inspektionsspegel med belysning

i **5**
Mer information



3,6 kg



LED

Ø 52,0 mm

Ø 31,0 mm

90,0 x 50,0 mm

3 x LR44

NY

210,-

5 | 1

inklusive snabbblåsning



550.1145

172 - 640 mm

i **4**
Mer information

140,-

45° 135° 0° 90°

550.1045

i **9**
Mer information

280,-

45° 135° 0° 90° 45° 90° 0°

550.1070

i **1**
Mer information

130,-

Piezo

115 mm

960.1110

i **1**
Mer information

280,-

300 mm

550.1060

i **8**
Mer information

280,-

95 mm

Ø 40 mm

49 mm

5 mm

Ø 1,6 mm

Ø 3,5 mm

Ø 4,5 mm

960.1265

i **11**
Mer information

420,-

Piezo

200 mm

20 mm

33 mm

Ø 1,6 mm

Ø 3,5 mm

Ø 4,5 mm

Ø 5 mm

30 mm

95 mm

95 mm

Ø 40 mm

ISO BUTAN

960.1160 Mikrolödnings-sats

i **283**
Mer information

2350,- 220 mm

Ø 0,5 - 6 mm Ø 0,5 - 6 mm
Ø 0,5 - 10 mm Ø 6,50 / 5,41 / 1,72 mm Ø 0,5 - 4 mm
Ø 1,0 - 3,2 mm

115.1400

i **1**
Mer information

143 mm

60,-

118.0013

i **1**
Mer information

EG II

från 50,-

| | EG II | längd m | bredd mm | pris SEK |
|---|----------|------------|-------------|-------------|
| A | 300.0113 | 3 m | 16 mm | 50,- SEK |
| B | 300.0114 | 5 m | 19 mm | 60,- SEK |
| C | 300.0115 | 5 m | 25 mm | 70,- SEK |
| D | 300.0116 | 8 m | 25 mm | 90,- SEK |

A 16 mm B 19 mm C 25 mm D 25 mm

i **5**
Mer information

temperaturreglering: 1≈50°C / 2≈100°C / 3≈200°C / 4≈350°C / 5≈550°C / 6≈650°C

260 mm

1 2 3 4 5 6

1 max. 450°C
2 max. 650°C

Användningsområden: Färgborttagning, fastlösnig av rör, krympning av PVC, färgborttagning, varmförsegling och böjning av plast, torkning, upptining etc.

420,-

960.1190

i **1**
Mer information

180°

IP 34

15+1 m

3x 1,5 mm²

230 V 50 Hz

1000/3000 W

10 A

1870,-

150.4217

i **12**
Mer information

145 mm

5,0 x 1,0 mm
5,0 x 1,0 mm
3,0 mm
3,0 mm
5,0 mm
5,0 mm
3,0 mm
2,0 mm
2,0 mm
5,0 mm
5,0 mm
5,0 mm

140,-

140.3050

Heb 2

i **5**
Mer information

200 mm

420,-

140.3000

Heb 2

i **1**

Mer information

280,-

138 x 69 x 31 mm

342

9 V

Data Hold

69 mm

138 mm

150.1495

i **1**

Mer information

3 - 48 V

140 mm

170,-

550.1503

Polaritets- och spänningstester 3 - 48 V

i **1**

Mer information

125 mm

6 - 24 V

70,-

550.1504

Testlampa 6 - 24 V

i **1**

Mer information

AUTOMATIC
DIGITAL MULTIMETER

143 x 70 x 16 mm

119

AAA

Data Hold

16 mm

143 mm

70 mm

690,-

150.1765

NCV

USB-A

USB-C

1

2

3

4

5

6

7

Nej. Beskrivning

- 1 Strömknappen
- 2 Funktionsomkopplare
- 3 Kapacitansbrytare
- 4 Belysningsbrytare
- 5 LCD skärm
- 6 NCV-sensorområde
- 7 Testledningar

| Symbol | Beskrivning |
|-------------|--------------------------------------|
| | DC spänning |
| | AC spänning |
| | Indikator för automatisk avstängning |
| | Indikator för lågt batteri |
| | Diodläge |
| | Textavsnitt |
| | Kapacitet |
| | Effektmätarförhållande |
| HOLD | Datahållningsfunktion |
| V, mV | Spänningsenhet: volt, millivolt |
| mF, µF, nF | Kapacitetsenhet |
| MΩ, KΩ, Ω | Motståndsenhet |
| NCV | Beröringsfri spänningsinduktion |
| Live | Testar levande linjer |
| KHz, Hz | Frekvensenhet |
| °C/°F | Celsius/Fahrenheit |

3 COLOUR ANALOG BAR

BUZZER ALARM

i **3**
Mer information

210 x 88 x 44 mm
655
9 V
Data Hold

490,-

max mätbar-tråddiameter 29,0 mm

150.0925

i **1**
Mer information

För lik- och växelspanning

| | |
|----|----------------------------|
| AC | 6 - 50 - 120 - 230 - 400 V |
| DC | 6 - 50 - 120 - 230 - 400 V |

330,-

550.1501

UNIVERSAL KOPPLINGSSKÅPSNYCKEL

i **1**
Mer information

MINI

42 mm

- 6 - 7 - 8 mm
- 9 mm
- 3 - 5 mm
- PH 2
- 7 mm

240,-

130.1010

i **1**
Mer information

71 mm

- 6 - 7 - 8 mm
- 9 mm
- 3 - 5 mm
- PH 2
- 7 mm

250,-

130.1015

i **1**
Mer information

61 mm

- 5 - 7 - 8 mm
- 9 - 10 mm
- 4 - 10 mm
- PH 2
- 7 mm

250,-

130.1020

Kabel-indragningstråd

10 meter 20 meter

från **70,-**

| | | | | | |
|----------|----------|--|----------|------------------|-----------|
| A | 150.0960 | | 1 | Ø 3,0 mm 10 m | 70,- SEK |
| B | 150.0970 | | 1 | Ø 4,0 mm 20 m | 140,- SEK |

i **1**
Mer information

490,-

Ø 3,0 mm

30 meter

115.1113 Kabelindragningshjälp

320,-

Mer information

- med låsanordning
- Mätslider med mm- och tumindelning
- med gängtabell

300.0510

350,-

Mer information

+/- 0,03 mm

- Med låsskruv och fininställning av rullar
- för utvändiga och invändiga mätningar samt nivå- och djupmätningar

300.0532

INFRARÖD TERMOMETER

-38° TIL 520°

Mer information

690,-

150.3040

790,-

Mer information

4

550.1290 Refraktometer

940,-

Mer information

4

550.1285 Refraktometer - optisk testutrustning för batteridensitet, frostskyddsmedel och AdBlue®-tillsats

i **4**
Mer information

280,-

11 x 115 mm
15 x 185 mm
18 x 320 mm
18 x 470 mm

911.8100 Bräckjärn-sats

i **4**
Mer information

XL

900 mm
600 mm

0°
45°
75°
90°

2490,-

911.8410 Bräckjärn-sats

i **22**
Mer information

Hydraulisk universal-avdragare-sats 2+3-armad

- låg glidfara genom automatisk förslutande avdragararmar
- 8 avdragarevarianter möjliga
- Extremt robust spindel med induktivt härdad gänga
- Låg kraftinsats
- Speciellt-verktygsstål

4210,-

700.1200

20 - 35 - 85 mm
235 mm
185 mm
10 t, AG 1.1/2" x 16G
225 mm
170 mm
120 mm
Ø max. 100 mm

i **13**
Mer information

NY FÖR NÖDSITUATIONER

1110,-

0% ✓ 85% ✓

för att lossa och skruva loss muttrar och bultar med skadade huvuden eller upp till 85% "rundade" huvuden

1250,-

Ringar böjda 45°

517.1555 6x7 - 8x9 - 10x11 - 12x13 - 14x15 - 16x17 - 18x19 mm

913.3930 8 - 9 - 10 - 11 - 12 - 13 - 14 - 15 - 16 - 17 - 18 - 19 mm

Inklusive 3/8" 1/2" 3/8"

JAG ÄR EN SKRUV, TA MIG HÄRIFRÅN!

i  **6**
Mer information

- För skruvar mellan M3 - M18
- Ger möjlighet för utskruvning av avrivna skruvar och bultar
- Koniskt utformad spiral
- i stabil plastlåda



240,-



150.1330 Skruvavdragare-sats



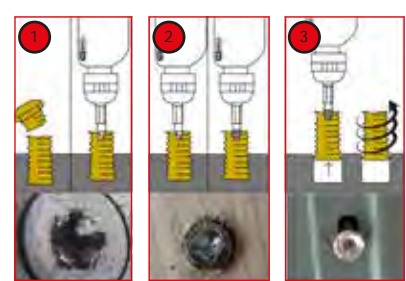

i  **34**
Mer information

TORION power



620,-



| | | |
|-----|---|--|
| 9 x |  | TE10 - TE15 - TE20 - TE25 - TE27 - TE30 - TE40 - TE50 - TE55 |
| 9 x |  | 1,5 - 2 - 2,5 - 3 - 4 - 5 - 6 - 8 - 10 mm |
| 7 x |  | 1,5 - 2 - 2,5 - 3 - 4 - 5 - 6 mm |
| 7 x |  | T10 - T15 - T20 - T25 - T27 - T30 - T40 |

150.7060    1/4" + 10 mm Torx-och insexkant-skrivar-utdragarsats

i  **25**
Mer information

Skruvutdragning-sats

- omfattande satssammansättning
- för borttagning av avbrutna gängbultar och skruvar
- inga skada på gängor
- endast obetydlig utvidgning av gängbult genom speciellt profilerat utdragnisstift



| Führungshülse drill guide | Hülse Innen-Ø mm guide | vorböhren Ø mm pre-drilling | aufbohren re-drilling | Stift pin | Art.Nr. Stift No. Pin | Mutter D nut D | Art.Nr. Mutter nut D | Stift + Mutter pin + nut |
|---------------------------|------------------------|-----------------------------|-----------------------|-----------|-----------------------|----------------|----------------------|--------------------------|
| 150.0501 | 4,0 / 3,2 | 3,2 | - | 3,2 | 150.0521 | SW 10 | 150.0511 | 150.0511S |
| 150.0502 | 4,8 / 3,2 | 3,2 | - | 3,2 | 150.0521 | SW 10 | 150.0511 | 150.0511S |
| 150.0503 | 4,8 / 3,2 | 3,2 | 4,8 | 4,8 | 150.0522 | SW 11 | 150.0512 | 150.0512S |
| 150.0504 | 4,8 / 3,2 | 3,2 | 4,8 | 4,8 | 150.0522 | SW 11 | 150.0512 | 150.0512S |
| 150.0505 | 6,0 / 4,8 | 4,8 | 6,4 | 6,4 | 150.0523 | SW 13 | 150.0513 | 150.0513S |
| 150.0506 | 7,0 / 4,8 | 4,8 | 6,4 | 6,4 | 150.0523 | SW 13 | 150.0513 | 150.0513S |
| 150.0507 | 7,0 / 4,8 | 4,8 | 8,0 | 8,0 | 150.0524 | SW 14 | 150.0514 | 150.0514S |
| 150.0508 | 7,0 / 4,8 | 4,8 | 8,7 | 8,7 | 150.0525 | SW 17 | 150.0515 | 150.0515S |
| 150.0509 | 9,0 / 6,5 | 6,4 | 8,7 | 8,7 | 150.0525 | SW 17 | 150.0515 | 150.0515S |
| 150.0510 | 9,5 / 6,5 | 6,4 | 8,7 | 8,7 | 150.0525 | SW 17 | 150.0515 | 150.0515S |



150.1305 M5 - M6 - M8 - M10 - M12 - M14 - M16

560,-

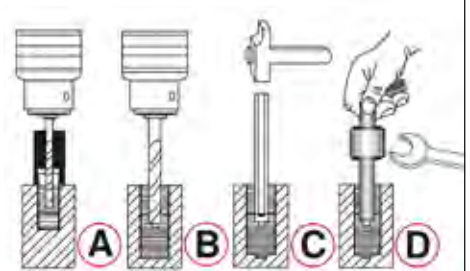



Mer information

Ståbult-urvidare-sats

- Yttersexkantdrivning 21,0 mm
- Med höger- och vänsterspännfunktion
- Säkert fäste genom 3 rullvalsar vardera
- In- och utskruvning utan besvärlig låsning av två muttrar på bulten
- Lämpad även för extralånga ståbultar - på grund av den genomgående borrarngen

690,-

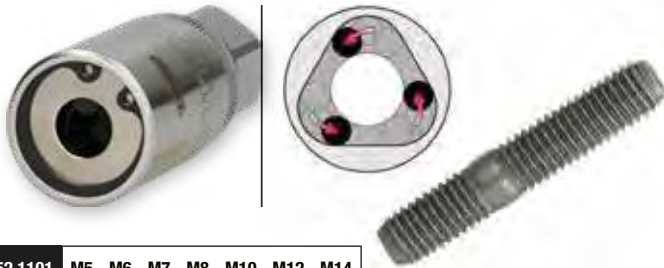

152.1101 M5 - M6 - M7 - M8 - M10 - M12 - M14



Mer information

HSS Co gängskärverktyg-sats i industri-kassett

- universell sats
- Handgängstapp med raka spår
- med justerbara vindsningsjärn och gängtappshållare
- Inklusive gängtolk och skruvmejsel
- kobolthaltigt högkvalitetsstål



DEN HAR ALLT



| | | |
|------|--|--|
| 33 x | | M3 - M4 - M5 - M6 - M8 - M10 - M12 M14 - M15 - M18 - M20 |
| 11 x | | M3 - M4 - M5 - M6 - M8 - M10 - M12 M14 - M15 - M18 - M20 |
| 6 x | | M3-M4 - M4,5-M6 - M7-M9 - M10-M11 - M12-M14 - M16-M20 |
| 2 x | | M1-M10 - M5-M20 |

6900,-

331.0754



Mer information

ALLA GILLAR ATT BÄRA DEN!

350,-



EN388



4131X

Mikrofinstickad

| | Storlek | innehåll |
|----------|---------|----------|
| 310.0490 | 7 | 12 par |
| 310.0491 | 8 | 12 par |
| 310.0470 | 9 | 12 par |
| 310.0475 | 10 | 12 par |
| 310.0480 | 11 | 12 par |



Mer information

60,-



310.0120

FLAMDESIGN

Mer information





690,-

310.0155

STEEL DESIGN

Mer information



690,-

310.0195



Tekniska data:

| | |
|---------------------------|--|
| Färgval: | steglöst justerbar från DIN 9-13 standardljusinställning DIN 4 |
| Omkopplings reaktionstid: | 1/25.000 s |
| UV/IR skydd: | 0,2 - 0,8 s Fördröjning (justerbar) |
| Drifttemperatur: | enligt EN169 / bis DIN 16 |
| Lagertemperatur: | -5°C till +55°C |
| Strömförsörjning: | -20°C till +70°C |
| Höjd: | över solceller |
| Bredd: | 220 mm |
| Längd: | 200 mm |
| Vikt: | 295 mm |
| Mått låda: | 480 g |
| Inspektionsfönster: | 110 x 90 x 9 mm |
| | 92 x 42 mm |

Universell tryckpump-atomiserare

Mer information

- I högvärdig polyetylen
- för olika kemikalier som t.ex. tvätt-, lösnings- och rengöringsmedel osv.
- ej lämpat för bromsrengöring
- Justerbart och stängbart sprayhuvud i mässing
- Tätningar i Viton®
- Kan användas upp och ner





från 210,-

| | | |
|----------|----|-----------|
| 150.8251 | 1L | 210,- SEK |
| 150.8252 | 2L | 280,- SEK |

Aluminium

Mer information

0,25 L

max. 8 bar (116 psi)

60°C / 140°F

115 mm

250 mm

NY

Speciellt för bromsrengörare

690,-

150.8272

i **16**
Mer information

Evolution SERIES

Skrapa-sats

- Bäst lämpad för borttagning av plakett, tätnings- och limrester
- Enkelt knivbyte genom lösande av räfflad mutter på spännfodret
- Praktiskt förvaringssystem genom bytbara knivformer
- Genom olika knivformer bäst lämpad för de mest varierande användningsområden
- Skrapare med 2-komponentshandtag

Reservblad: 907.2202, 907.2203, 907.2204, 907.2205, 907.2206

NY

5x 12 mm
5x 16 mm
5x 20 mm

145 mm

180,-

907.2255

i **27**
Mer information

Kniv-sats

145 mm

5x 19 mm

5x 12 mm
5x 16 mm
5x 16 mm
5x 20 mm

145 mm

280,-

907.2200

Skrapkniv

A **B**

110 mm 145 mm

från 60,-

| | | | | | |
|----------|----------|--|--|-------------|----------|
| A | 907.2240 | | | 110 x 39 mm | 60,- SEK |
| B | 907.2242 | | | 145 x 40 mm | 70,- SEK |

Fällkniv med låsning

A **B**

190 mm 220 mm

från 160,-

| | | | | | |
|----------|----------|--|--|-------------|-----------|
| A | 907.2105 | | | 190 x 25 mm | 160,- SEK |
| B | 907.2190 | | | 220 x 28 mm | 170,- SEK |

i **2**
Mer information

155 mm 97 mm

210,-

907.2172 Fällkniv-sats

i **3**
Mer information

250 mm

560,-

118.0050 Spak-plåtgenomgångssax-sats

Wi-Fi-videoskop-sats mit Ø 5,5 mm 0° HD frontkamera-sond

Mer information

HD

Wi Fi

Ø 5,5 mm

Ø 5,5 mm

3500 mm

IP68

560,-

550.7560

EXTEND YOUR EYE

från 3320,-

Hylsa i rostfritt stål
Skruvanslutning
för tillbehör

Krondesign
(Skydd +
optimal
rengöring)

Kamera

Lins

LED

Hylsa i rostfritt stål
med utvändiga
Safirglas

1500 mAh
Li-polymer

Ø 6,0 mm

Ø 4,5 mm

1000 mm

Anslut sond

3,5"

USB 2.0

microSD

HD

6 dimmbara
mini-LED-lampor

0° 90°

Ø

A 550.7500 5 6,0 mm 0° + 90° 3320,- SEK

B 550.7530 7 4,5 mm 0° + 90° 4140,- SEK

1000 mm

50 mm

IP 67

AVI 1280 x 720

JPG

150 mm

-10°/+60°C

A magnet

B magnet

Krok





Mer information



6 dimmbara mini-LED-lampor

Ø 3,9 mm



0°
Kontrollerbar

180° 180°



180°
vridbar vridbar 360°



Anslut sond



3000 mAh Li-polymer

IP 67

AVI 1280 x 720

JPG

150 mm

-10°/+60°C

NY

+ 32 GB

6210,-

550.7550 HD-videoskop-sats med Ø 3,9 mm 180° och 0° HD frontkamera-sond, flexibelt PVC-hölje





Ø 12 - 35 MM



104.5060

Inox

Steel

Spärr-rörskärare

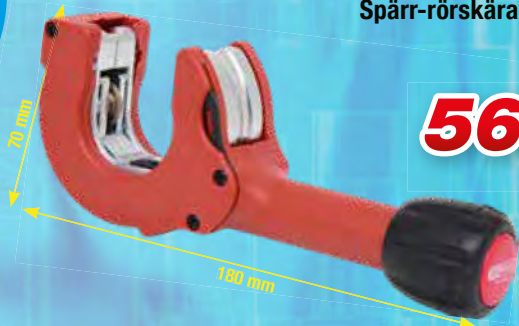

560,-



Ø 28 - 67 MM



104.5050

Inox

Steel

Spärr-rörskärare



1800,-



116.1050



FUGENFIX[®]

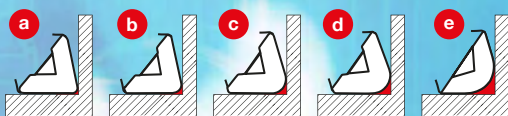

110,-

FUGENFIX silikonkrapa- och utdragarsats



903.3300

Gäng-tapp-sats 3/8" - 1 1/4"

3/8"
1/2"
3/4"
1"
1.1/4"

1110,-



116.2000



800,-

Ventifix

130.3000

1/2"



280,-

Universal nivå nyckel-sats 3/8" - 1"

903.5902

- Eldtemperatur ca 1700°C
- Arbetstemperatur ca 650°C
- Mjuklödning upp till max Ø 22 mm
- Leverans utan gaskartusch
- Användning endast med standard högeffektbrännare
- Grundstomme i plast



350,-

Universal patronlödningsanordning med piezotändning

907.2113

Japan-kapsåg, dubbeltandad



17x pro 2,5cm

8x pro 2,5cm

325 mm

250,-



850.0300

SMARTBAG universell verktygsväska

1020,-

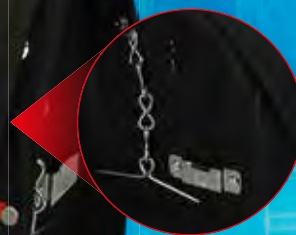



Kompakt och robust utförande:

Tack vare högkvalitativ plast och fasta skruvkopplingar, är det laddningsbara batteriet extra bra skyddat mot mekanisk påverkan.



Värmeavledning:

Flänsarna gör att värme leds bort till den omgivande luften likt en radiator.



Aktiv luftkyllning:

(endast med 8,0 Ah snabbbladdare) Den integrerade fläkten på 8,0 Ah snabbbladdaren levererar under laddning genomgående kall frisk luft för att reducera den värme som uppstår i batteriet och laddaren på bästa möjliga vis. Genom denna skonsamma laddning ökas batteriets livslängd avsevärt.



18 V eMONSTER laddningsbara batterisystem

Det kraftfulla 18 V eMONSTER batterisystemet förenar en rad professionella batteridrivna elverktyg. Alla apparater kan använda samma batterisystem. Sortimentet är universellt och utökas ständigt. Varje ny apparat kan dessutom användas ihop med detta batterisystem. Du kan använda batterisystemet i många år och utöka det med eMONSTER 18 V-apparater – du stannar i samma batterifamilj.



Extra skydd för lång batterilivslängd:

Överspänningskydd:

- Skydd mot otillåtet höga spänningskällor

Lågspänningskydd:

- Skydd mot djupurladdning under drift

Temperaturhantering:

- Samspel mellan apparat och batteri för att förhindra överbelastning av batteriet



Optimerad celltilldelning:

Rörstrukturen gör att de enskilda cellerna förs till den värmeavledande plasten. På så vis uppstår en fast kontakt mellan cellen och den värmeavledandeplasten. Det finns inte längre något isolerande luftskikt som minskar värmeavledningen.





eMONSTER borstlös sladdlös borrar-/skruvdragarset

MINI



2210,-

Vridmoment max: 40 Nm
Adapter: 10 mm snabborrchuck

515.6400



eMONSTER borstlös sladdlös slagborr-/ borrar-/skruvdragarset



2630,-

Vridmoment max: 60 Nm
Adapter: 13 mm Röhmmetall-schnabbchuck

515.6300

INKLUSIVE



Batterispänning: 18,0 V
max. laddström: 3 A

Batterispänning: 18,0 V
Batteriteknologi: Litium-Ijoner
Batterikapacitet: 2,0 Ah

leverans inkl två 2,0 Ah batterier och 3 A snabbaddare

INKLUSIVE



eMONSTER 1/2" borstlös sladdlös slagnyckelsats



3730,-

Max. lös-vridmoment: 690 Nm
Adapter: 1/2"

515.6100



eMONSTER Borstlös sladdlös vinkelslipsats

INKLUSIVE



Batterispänning: 18,0 V
max. laddström: 8 A

Batterispänning: 18,0 V
Batteriteknologi: Litium-Ijoner
Batterikapacitet: 4,0 Ah

leverans inkl två 4,0 Ah batterier och 8 A snabbaddare



4140,-

Varvtal: 9000 varv/min
Vibrationsacceleration: < 4,831 m/s²
3,371 m/s²

515.6200



32

Mer information

1/4" TORSIONpower bitsats i eMONSTER-batteri-design, 32 delar

140,-

515.6932

| | | |
|-----|--|--|
| 1 x | | 1/4" |
| 1 x | | 1/4" |
| 4 x | | 3 - 4 - 5 - 6 mm |
| 4 x | | PH1 - 2 x PH2 - PH3 |
| 4 x | | PZ1 - 2 x PZ2 - PZ3 |
| 4 x | | 3 - 4 - 5 - 6 mm |
| 7 x | | T10 - T15 - T20 - T25 - T27 - T30 - T40 |
| 7 x | | TB10 - TB15 - TB20 - TB25 - TB27 - TB30 - TB40 |



kan anslutas och läsas på 18 V eMONSTER-apparater som batteri-atrapp

HÄR GÅR DET UN DAN!

1.390 N·m

1/2"

90 mm

165 mm

515.1150

1  **2760,-**

1.390 N·m

1/2"

95 mm

190 mm

515.1270

2  **2070,-**

1.084 N·m

1/2"

115 mm

180 mm

515.1315

3  **970,-**

1.600 N·m

1/2"

170 mm

188 mm

515.1200

4  **970,-**

2.000 N·m

3/4"

170 mm

185 mm

515.3400

5  **1730,-**

1.690 N·m

1/2" 3/4"

175 mm

200 mm

515.1210

6  **2070,-**

7  **2630,-**

3.405 N·m

3/4" 1"

40 mm

350 mm

515.3250

9  **11730,-**

11  **11730,-**

3.405 N·m

3/4" 1"

195 mm

350 mm

515.3260

10  **12490,-**

12  **12490,-**

| | |  |  |  |  |  |  |  |  |  |  |  | |
|----|----------|---|---|---|---|---|---|---|---|---|---|---|------|
| | | MAX Nm | U/min | m/s ² | dB(A) | dB(A) | U/min | PT | | | | Kg | |
| 1 | 515.1150 | 1/2" | 1390 | 10.000 | <9,18 | 102,0 | 113,0 | 135 | 1/4" | - | ✓ | - | 1,08 |
| 2 | 515.1270 | 1/2" | 1390 | 10.000 | <9,18 | 102,0 | 113,0 | 135 | 1/4" | - | ✓ | ✓ | 1,3 |
| 3 | 515.1315 | 1/2" | 1084 | 9000 | <10,36 | 106,0 | 115,0 | 169 | 1/4" | - | ✓ | - | 1,2 |
| 4 | 515.1200 | 1/2" | 1600 | 8500 | <17,5 | 89,9 | 100,9 | 169 | 1/4" | ✓ | ✓ | - | 2,1 |
| 5 | 515.3400 | 3/4" | 2000 | 8500 | <17,25 | 91,0 | 100,9 | 196 | 1/4" | ✓ | ✓ | - | 2,2 |
| 6 | 515.1210 | 1/2" | 1690 | 7930 | <17,9 | 87,0 | 98,0 | 178 | 1/4" | ✓ | ✓ | - | 2,1 |
| 7 | 515.3785 | 3/4" | 1690 | 7930 | <13,56 | 88,0 | 104,0 | 178 | 1/4" | ✓ | ✓ | - | 2,2 |
| 8 | 512.0002 | 1/2" | 2300 | 8500 | <8,69 | 99,7 | 110,9 | 244 | 1/4" | ✓ | ✓ | ✓ | 1,6 |
| 9 | 515.3250 | 3/4" | 3405 | 6200 | <12,57 | 115,5 | 104,5 | 283 | 1/2" | ✓ | ✓ | - | 6,7 |
| 10 | 515.3260 | 3/4" | 3405 | 6200 | <12,88 | 115,5 | 104,5 | 283 | 1/2" | ✓ | ✓ | - | 7,7 |
| 11 | 515.3270 | 1" | 3405 | 6200 | <12,57 | 115,5 | 104,5 | 283 | 1/2" | ✓ | ✓ | - | 6,7 |
| 12 | 515.3280 | 1" | 3405 | 6200 | <12,88 | 115,5 | 104,5 | 283 | 1/2" | ✓ | ✓ | - | 7,8 |

 Kraftfullt slagverk med dubbla hammare

 Högprestanda Jumbo-mekanism

 BITURBO-teknologi

Alla priser i SEK exklusive moms gäller tills 2024-09-30

i **1**
Mer information

Fettutsöndring: Vardera ett slag per avtryckarmanövrering

200 mm

400 g

400 mm

920,-

515.3900 Tryckluft-fettspruta för slagvis fettutmatning

i **1**
Mer information

från 350,-

PU

| | | | | |
|----------|---------|----------|--------|-----------|
| 515.3330 | 6,0 mm | G1/4" AG | 8,0 m | 350,- SEK |
| 515.3335 | 8,0 mm | G1/4" AG | 15,0 m | 490,- SEK |
| 515.3340 | 10,0 mm | G3/8" AG | 15,0 m | 560,- SEK |

i **1**
Mer information

140,-

reglerbara

100 mm

515.1901 Tryckluft-blåsmunstycke med flödesreglering

i **3**
Mer information

280,-

510 mm

330 mm

95 mm

515.1921 Tryckluft-blåsmunstycke-sats

Automatisk tryckluftslangvinda

15 m

1,5 m

180°

STOP

i **1**
Mer information

1660,-

Ø 10 MM X 15 M

A

Tekniska data:

| | |
|----------------------|----------|
| Inre slangdiameter: | 10,0 mm |
| max. tryck: | 20,0 bar |
| Anslutningsgångning: | 1/4" |

515.3440

i **1**
Mer information

2490,-

Ø 13 MM X 15 M

B

Tekniska data:

| | |
|----------------------|----------|
| Inre slangdiameter: | 13,0 mm |
| max. tryck: | 20,0 bar |
| Anslutningsgångning: | 3/8" |

515.3445

i **1**
Mer information

480 mm
320 mm
36 mm
1.150 mm
36 mm
550 mm

från
170,-

| | | |
|----------|----------|--------------------|
| | ↔ | |
| A | 500.8040 | 480 mm 170,- SEK |
| B | 500.8045 | 1.150 mm 560,- SEK |

i **1**
Mer information

360 mm
365 mm
360 mm

1
690,-

500.8020

i **1**
Mer information

400 - 540 mm

2
830,-

500.8030

i **1**
Mer information

TÅL HÖG BELASTNING MED 135 KG

max. 135 kg
463 - 580 mm
360 mm

3
970,-

500.8004

i **1**
Mer information

400 mm
85 mm
490 mm
1.040 mm

4
970,-

500.8011

i **1**
Mer information

420 mm
145 mm
1.200 mm
510 mm
145 mm

6
1380,-

500.8000

| | 1 | 2 | 3 | 4 | 5 | 6 |
|-------------------------|----------|------------------|------------------|-----------------|-----------|------------------|
| Tekniska data: | 500.8020 | 500.8030 | 500.8004 | 500.8011 | 500.8090 | 500.8000 |
| Färg | röd | röd | röd | röd | röd | röd |
| Material | stålrör | metall | metall | metall | plast | metall |
| antal länkrullar | 4 | 5 | 5 | 6 | 6 | 6 |
| rullbar | ✓ | ✓ | ✓ | ✓ | ✓ | ✓ |
| däcktyp | plast | plast | gummi | plast | plast | plast |
| vaderad | ✓ | ✓ | ✓ | ✓ | ✗ | ✓ |
| justerbar i höjd | ✗ | ✓ | ✓ | ✓ | ✗ | ✓ |
| förpackningens innehåll | 1 | 1 | 1 | 1 | 1 | 1 |
| totallängd L i mm | 365,0 mm | 370,0 mm | 360,0 mm | 1040,0 mm | 1030,0 mm | 1200,0 mm |
| bredd B | 360,0 mm | 370,0 mm | 360,0 mm | 490,0 mm | 480,0 mm | 420,0 mm |
| höjd H | 360,0 mm | 420,0 - 540,0 mm | 463,0 - 580,0 mm | 85,0 - 400,0 mm | 115,0 mm | 145,0 - 510,0 mm |
| total dragkraft kg | 90 kg | 90 kg | 135 kg | 90 kg | 120 kg | 90 kg |

i **1**
Mer information

DEN LÄTTASTE

115 mm
480 mm
1.030 mm

5
940,-

500.8090

i  **3**
Mer information

Genialiskt flexibel

NY

620,-

500.3077 **Sats med verktygsfack av silikon**

1 53 x 29,5 x 3,2 cm

2 25,5 x 23,3 x 2,4 cm

3 27,5 x 14,5 x 2,4 cm

i  **1**
Mer information

- med glidfast profil på l p plattformen
- med stor plattform f r stabilitet
- Plastkanter p  f tterna skyddar l p plattformen och marken

1380,-

800.0960 **Aluminium-s kerhets-serviceplattform**

960 mm

300 mm

495 mm

max. 150 kg

i  **1**
Mer information

- med profil av r fflad pl t p  steget
- Ingen tippning p  grund av sneda st ndf tter
- f llbar och d rmed platsbesparande vid f rvaring

760,-

800.0965 **Aluminiumstege**

600 mm

440 mm

620 mm

max. 150 kg

T V SUD
Safety Certified
Professional Approved
tuv-sud.com
ps-cert

-TESTAT F R DIN S KERHET!

Mer information

1

MAXIMAL ARBETSYTA

16560,-

XXL

840 mm

2000 mm

680 mm

865.0201 **XXL-Arbeitsbank med 3 lådor och dörr**

Mer information

1

LITEN OCH STOR PÅ SAMMA GÅNG!

257 - 1380 mm

845 - 1320 mm

2490,-

257 - 1380 mm

500.8100 **Universell teleskopisk universalvagn med hjul**

Mer information

1

Ø 440 mm

180°

NY

3 5000 rpm, 57 dB, 4,9 m/s, 56,9 W

2 4500 rpm, 51,5 dB, 4,3 m/s, 53 W

1 4000 rpm, 48 dB, 3,5 m/s, 49 W

690,-

610 mm

570 mm

EXTREM TYST

ULTRALÄTT

< 3,5 KG

999.2000 **Verkstadsfläkt, 70 Watt**

Mer information

1

Skruvstäd

360°

360° med vridskiva

från 2290,-

Backar och smidesståd inductivt härdade

| | | | |
|----------|--------|----|------------|
| 914.0004 | 120 mm | 4" | 2290,- SEK |
| 914.0005 | 140 mm | 5" | 2470,- SEK |
| 914.0006 | 160 mm | 6" | 2630,- SEK |
| 914.0008 | 200 mm | 8" | 3180,- SEK |

i

Mer information

| | |
|-----------------------------|---------------------|
| max. 8 bar (116 PSI) | 60° C 140° F |
|-----------------------------|---------------------|

280,-

1

Water

2

Detergent

3

Max. 40° C

Max.

4

5

Switch

Lock

150.8271 Tryck-pump-skum-sprayer (skummare)

i

Mer information

1180,-

350 mm

650 mm

www.kstools.com
500.8013

500.8013 Transportabel pall

i

Mer information

| | |
|-------------|--------------|
| 6,3 bar | 96 L/min |
| 92 dbA | 1/4" PT |

560,-

145 mm

3/8" - Ø 10 mm

www.kstools.com
515.5090

515.5090 Tryckluft-sugblåspistol



Mer information

Ø 90 mm

15 mm

M8

90,-

515.1243 Folieraderare



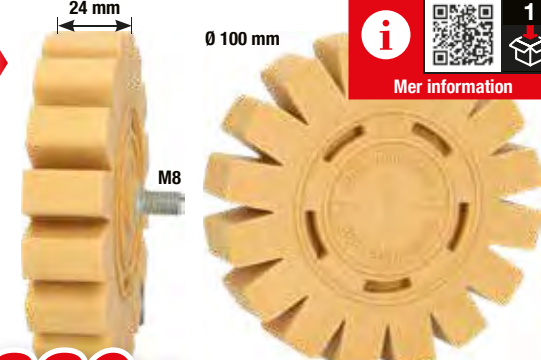

Mer information

Ø 100 mm

24 mm

M8

220,-

515.1247 Folieraderare med lameller



Mer information

Set-pris = 6x

6

420,-

515.1285





Mer information

Set-pris = 6x

6

1250,-

515.1366





Mer information

1

reglerbara

ON - OFF

Industriellt kullager

360°

30°

1960,-

515.1980 Tryckluft-rengöringspistol



| | | |
|-----------------|------------|------------|
| 1/4" NPT | 8000 | 160 Liter |
| 6,3 bar (90psi) | 3/8"-10 mm | <3,90 min* |
| 106 dbA | 95 dbA | 1000 ml |

TILLVAL



Mer information

1

90,-

515.1983 Borsttillbehör



Mer information

1

90,-

515.1986 Penselborste

i **6**
Mer information

420,-

510 mm

4 mm
8 mm
10 mm

4 mm
8 mm
10 mm

245 mm

140.2370 Clips-mejsel-sats

i **11**
Mer information

280,-

180 mm 200 mm 200 mm 200 mm 210 mm

160 mm 200 mm 200 mm 180 mm 200 mm 200 mm

911.6205 MASTER plastkil-sats

i **1**
Mer information

- Undanröjer dålig lukt och desinficerar fordonets inre
- Automatisk urkoppling i luktreduceringsmodus efter 60 minuter
- Arbetar utan kemiska tillsatser, därför garanterad rostfri rengöring
- Lämnar inte ens några spår på känsliga ytor
- Tar bort mögel/bakterier/svamp/kvalster

173 mm

49 mm

122 mm

550.1183 Plasma-luftrengöring med joniseringsteknik

1110,-

i **1**
Mer information

- idealisk för rengöring av smala rör, slangar eller avlopp
- dubbelsidig användning
- flexibel rostfri axel
- nylonborstar

60,- NY

Ø 16 mm

Ø 22 mm

150.1762 Flexibel rengöringsborste

i **7**
Mer information

Ø 0 - 38 mm

Ø 0 - 48,5 mm

Ø 0 - 65 mm

Ø 0 - 30 mm

Ø 0 - 45 mm

Ø 0 - 45 mm

Ø 0 - 60 mm

1110,-

115.1055 Bilslangklämtång-sats

i  **3**
Mer information

140,-

Ø 15 mm Ø 30 mm Ø 60 mm

150 mm 180 mm 250 mm

115.5050



i  **3**
Mer information

180,-

Ø 15 mm Ø 35 mm Ø 23 mm

155 mm 255 mm 165 mm

115.5055

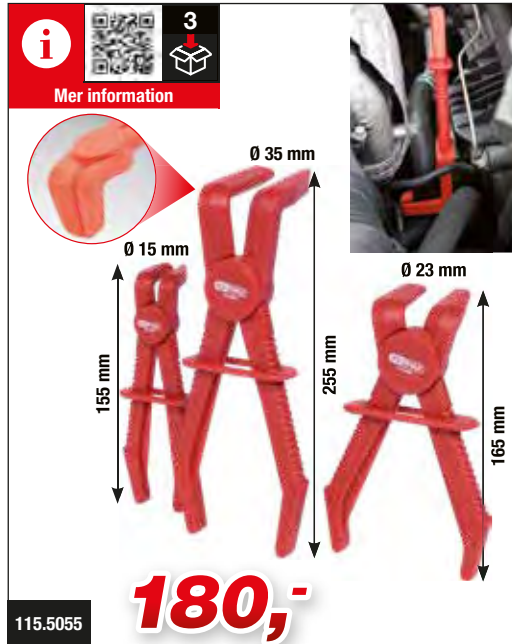

i  **1**
Mer information

210,-

Utsugnings- och påfyllningshandpump

150.9221 



i  **1**
Mer information

280,-

100 mm

3/8" specialhylsnyckel för sugrörs-skruvförband

150.2519 



i  **1**
Mer information

280,-

12V 5A 60W
Richtung Direction
150.2620

PETROL DIESEL OIL

Elektrisk oljeuppsugnings- och överföringspump

150.2620



i  **1**
Mer information

70,-

Utbytbar hylsa för 30-45 mm och 60-80 mm slangklämmor

NY

2

30 mm

1

2-i-1 specialhylsnyckel för slangklämmor med 3-punktsprofil

115.0915



i  **1**
Mer information

180,-

NY

1/2"

108 mm

150.1919

Kylarlock utdragnings verktyg för VAG







25

Mer information









0 - 2,5 bar



max. 76 cm



0 - 200 °C
0 - 400 °F



1600 mm



R123
R124



R123
R125



#1



#2



#3



M50 x 2,5



M42 x 3



M58 x 3



M62 x 3



M48 x 4



M45 x 3



M50 x 2,5



M60 x 4



M52 x 3



M48 x 2,5



M42 x 2,5



M50 x 3



M46 x 3



M34 x 2,5



75 mm

2490,-

150.1930

MASTER
kylsystem-diagnos-service-sats







1

Mer information

Koppling 7,2 mm till 4,4 mm



7,2 mm



4,4 mm

NY

280,-

150.1936







1

Mer information

Koppling 4,4 mm till 7,2 mm



4,4 mm



7,2 mm

NY

350,-

150.1937

i  **8**
Mer information

250 ml

1380,-

OPTIONELLT

210,-

150.1914

150.1910 CO2-cylinderhuvud-läckagetest-sats

i  **3**
Mer information

GENIALISKT FLEXIBEL

53 x 29,5 x 3,2 cm

1

2

25,5 x 23,3 x 2,4 cm

3

27,5 x 14,5 x 2,4 cm

NY

620,-

500.8077 Sats med verktygsfack av silikon

i 2
Mer information

EcoBoost

350,-

NY

180 mm + 215 mm

14 mm + 16 mm

FÖR FORD ECOBOOST-MOTORER 1,0 LITER

FÖR FORD ECOBOOST-MOTORER 1,5 LITER

517.1135 **Tändstiftshylssats för EcoBoost-motorer**

i 2
Mer information

M20 x 1.5 + M22 x 1.5

27 mm

13 mm

- för skärning av rostiga och skadade sondgångar
- idealisk för NOX- och partikelfiltersensorer på avgassystem
- med 6 skäreppor för idealisk centrering
- särskilt kort konstruktion
- med rengöringsspar i styrtappen

med 6 skäreppor för idealisk centrering

med rengöringsspar i styrtappen

2490,-

150.2540 **Gängskärarsats med styrtstift för sensorer**

GENIALISKA PROBLEMLÖSARE

NY

i 1
Mer information

Gängtapp med styrhylsa

- för skärning av rostiga och skadade sondgångar

L2
L1

13 mm

med 6 skäreppor för idealisk centrering

med rengöringsspar i styrtappen

1380,-

| | | | L1 | L2 | | | |
|----------|----------|----------------------------|------------|-------|-------|-------|------------|
| A | 150.2541 | för temperatursensorer | M12 x 1,25 | 55 mm | 33 mm | 13 mm | 1380,- SEK |
| B | 150.2542 | för temperatursensorer | M14 x 1,5 | 45 mm | 30 mm | 13 mm | 1380,- SEK |
| C | 150.2543 | för lambdasonder | M18 x 1,5 | 42 mm | 27 mm | 13 mm | 1380,- SEK |
| D | 150.2544 | för NOX-sensorer | M20 x 1,5 | 50 mm | 27 mm | 13 mm | 1380,- SEK |
| E | 150.2546 | för partikelfiltersensorer | M22 x 1,5 | 50 mm | 27 mm | 13 mm | 1380,- SEK |

i  **1**
Mer information

280,-



1 **2**

500.7505 Tändspole-avdragare för stav-tändspolar



i  **7**
Mer information

FÖR VAG- OCH OPEL-MOTORER

970,-



1 **2** **3** **4** **5** **6** **7**

500.7570 T-handtag-tändspole-avdragare-sats för VAG och Opel motorer



i  **7**
Mer information

120 ml 120 ml



6x10
6x6
6x8
6x4
600 mm
Ø 6x9 mm

2350,-

150.1900 Tryck- och undertryckspumpsats



i  **24**
Mer information



690,-

700.1280 Universal axeltättningsring och packbox monterings verktyg sats



i **1**
Mer information

max. 165 mm

560,-

M 12 x 75 mm

3/8" 17 mm

30 mm

40-165 mm

Universal-räffla-remskiva-avdragare
Ø 40-165 mm

150.3170

i **1**
Mer information

NY

1/4" 13 mm

• för spänning och lossning av spännrulle för kuggrem
• justerbar, universellt användningsbar
• Innerfyrkantadrev enligt DIN 3120 / ISO 1174
• Med yttersexkantdrivning 13,0 mm
• Behandlat med fosfor

Ø 3,0 mm

8 - 25 mm

280,-

Universal-tappnyckel
för spännrulle för kuggrem, justerbar

150.3046

i **1**
Mer information

Användningsområden: Citroën, Peugeot, Opel och Toyota med 1,0 och 1,2 bensinmotorer (motor kod: ZMZ (EBOF / EBO) / HM01 (1PP) / HMV, HMZ (EB2) / HMZ (EB2 / EB2F) / HMT (EB2D) / HMU (EB2D) / HNZ (EB2DT) / HNY (EB2DTS) / HMV (EB2M) / HMY (EB2M) / B12XE (EB2F) / D12XE (EB2FA) / B12XHL (EB2DT) / D12XHL, F12XHL (EB2ADT) / B12XHT (EB2DTS) / D12XHT, F12XHT (EB2ADTS))

140,-

Testverktyg för kuggrem för PSA

400.2118

i **1**
Mer information

M 15 x 1,5 x 71 mm

17 mm

490,-

27 mm

70 mm

Universal blockavdragare 3-armars

150.3130

i **22**
Mer information

• för montering och avmontering av hårda till öppna CLIC-fjäderförslutnings-ledningskopplingar vid bränsle-, luftkonditioneringsanläggnings-, luft- och hydraulledningar
• Inga skador på stickkopplingar, bränsleledningar och bränsleslangar
• Snabb och enkel separation av bränsleledningar
• för nästan alla vanliga europeiska, asiatiska och amerikanska fordonstyper

115.1260 Kabelanslutnings-upplåsnings-sats

690,-

5/16" 1/4" 5/16" 3/8" 3/8" 1/2" 5/8" 7/8"

3/8" 1/2" 5/8" 3/4" 5/16"

3/8" 1/2" 5/8"

3/4" 7/8" 5/16" x 3/8"

5/16"



Mer information

MED 3 873 SLAG PER MINUT SLÅR DEN ALLT!

- inklusive 7 adaptrar för nära nog alla injektorer
- enormt hög slagverkan (3365 (6,3 bar) / 3873 (8 bar) slag per minut)
- för påbyggnad av fastbrända injektorer i cylindrhuvudet
- med motsvarande adapter skruvas utdragaren fast i den injektor som sitter fast
- lägre platsbehov på grund av kompakt konstruktion



| | | |
|------------------|-----------------------|-----------|
| 223 L/min | 3/4"-19 mm | 108,4 dbA |
| 6,3 bar (90 psi) | 71,9 m/s ² | 6 mm |
| 12 bar | 119,4 dbA | M18 x 1,5 |



| | | |
|----------|---------------|--------------------------------------|
| A | M25 x 1,0 | Siemens |
| B | M20 x 1,0 | Denso |
| C | M27 x 1,0 | Siemens |
| D | M27/M17/10 mm | Bosch/Fiat/BMW/PSA/ Mercedes/Renault |
| E | M18 x 1,5 | Adapter |
| F | M17 x 1,0 | Bosch/Mercedes |
| G | M16 x 1,0 | Toyota |
| H | M14 x 1,5 | Bosch/Delphi/BMW |



BOSCH ✓
DENSO ✓
DELPHI ✓
SIEMENS ✓
 ... ✓

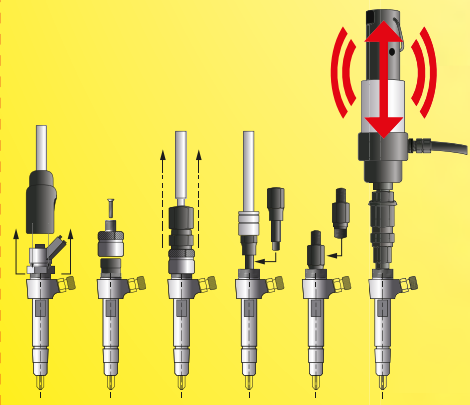

3730,-

152.1130 Utdragarsats för tryckluftsinjektorer

Alla priser i SEK exklusive moms gäller tills 2024-09-30

i **6**
Mer information

285 - 875 mm

TELESKOPSTÅNG

150 - 675 mm

500g

200g

1000g

2000g

3000g

Ø 4 mm

Ø 13 mm

Ø 16 mm

Ø 19 mm

400 mm

510 mm

NY

380,-

550.1090 Flexibel och teleskopisk magnethållare och inspektionspegelset

i **1**
Mer information

125 mm

6 - 24 V

70,-

550.1504 Testlampa 6 - 24 V

i **1**
Mer information

170,-

3 - 48 V

Polaritets- och spänningstester

550.1503 3 - 48 V

i **2**
Mer information

1800,-

25 m

6 - 24 V

Funktionstestlampa

150.1655

i **2**
Mer information

830,-

150.3075 kortslutningsdetektor

1 Mottagare

2 Sändare med krokodilklämmor





Mer information





5110,-



 **Batteriladdning**

 **Underhållsladdning**

 **Reparera batteriet**

 **Likströmmatning**

 **med omkastare mellan 12 och 24 Volt**

Temperatursensor



Tekniska data:

| | |
|--------------------|--|
| Batterikapacitet: | 12V: 75-500Ah - 24V: 45-250Ah |
| Spänningsområde: | 220-240V AC, 50/60HZ |
| Laddningsspänning: | 14,4V - 25A (12V), 28,8V - 12,5A (24V) |
| Frekvensområde: | 50 Hz |
| Ledning: | H05RN-F 2x1,0 mm ² |

550.1745 **12 V + 24V SMARTcharger högfrekvens-batteriladdare 25 A / 12,5A**







Mer information





5080,-

 **Batteriladdning**

 **Underhållsladdning**

 **Reparera batteriet**

 **Likströmmatning**

12 V / 24 V Digital-batteri- och laddningssystemtestare med integrerad skrivare



Tekniska data:

| | |
|------------------------|-----------------|
| Display: | digital |
| Arbetsområde CA / MCA: | 40-2.000 CCA |
| Arbetsområde CCA: | 40-2.000 CCA |
| Arbetsområde DIN: | 40-2.000 CCA |
| Arbetsområde EN: | 40-2.000 CCA |
| Arbetsområde IEC: | 40-2.000 CCA |
| Arbetsområde JIS#: | 40-2.000 CCA |
| Arbetsområde SAE: | 40-2.000 CCA |
| Arbetstemperatur: | 0°C till +55°C |
| Frekvensområde: | 100 Hz |
| Mätområde: | 9-36 V |
| Mätnoggrannhet: | +/- 0,5 Megaohm |
| Spänningsområde: | 9-36 V |

550.1649





Mer information





8280,-

 **Batteriladdning**

 **Underhållsladdning**

 **Reparera batteriet**

 **Likströmmatning**

12 V + 24 V batteri-booster - mobilt starthjälpssaggregat 1400 A



Tekniska data:

| | |
|----------|--------|
| 12/24 V | 1400 A |
| PEAK AMP | 4800 A |
| 1,5 m | 15 m |
| 2x22 A6 | |

550.1720

SAFETY Xtreme



intelligent säkerhetskoncept undviker användarfel:

säkerhetskrets ger ström på plintarna först då:

- korrekt anslutning har gjorts (polaritet)
- anslutningen är kortslutningssäker
- rätt spänning ligger an
- fordonsbatteriet är OK

i  **26**
Mer information













3/8"

4560,-

Verktogsats med isolerade verktyg för hybrid- och elfordon

117.1895

| | | |
|------|---|--|
| 2 x |  | 4 mm - 5,5 mm |
| 2 x |  | PH1 - PH2 |
| 6 x |  | 6 - 8 - 10 - 12 - 13 - 17 mm |
| 1 x |  | 185 mm |
| 1 x |  | 165 mm |
| 1 x |  | 3/8" |
| 1 x |  | 3/8": 200 mm |
| 1 x |  | 3/8": 125 mm |
| 10 x |  | 3/8": 8 - 10 - 11 - 12 - 13 14 - 16 - 17 - 19 - 22 mm |
| 1 x |  | 200 mm |

i  **43**
Mer information

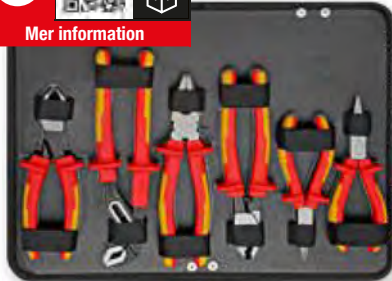



















3/8"

7800,-

Verktogsats med isolerade verktyg för hybrid- och elfordon

117.1890

| | | |
|------|---|---|
| 4 x |  | 2,5 - 3 - 3,5 - 4 mm |
| 3 x |  | PH1 - PH2 - PH3 |
| 3 x |  | T20 - T25 - T30 |
| 1 x |  | 210 mm |
| 1 x |  | 185 mm |
| 1 x |  | 165 mm |
| 1 x |  | 215 mm |
| 1 x |  | 165 mm |
| 1 x |  | 240 mm |
| 2 x |  | 10 - 25 mm |
| 1 x |  | 180 mm |
| 1 x |  | 3/8" |
| 15 x |  | 3/8": 6 - 7 - 8 - 9 - 10 11 - 12 - 13 - 14 - 16 17 - 18 - 19 - 20 - 22 mm |
| 2 x |  | 3/8": 150 - 250 mm |
| 3 x |  | 3/8": M8 - M10 - M12 |
| 1 x |  | Ø 200 mm |
| 1 x |  | 200 mm |
| 1 x |  | 500 m |

i  **18**
Mer information



4560,-

Blocknyckelsats med isolering

118.1500

| | | |
|------|---|--|
| 18 x |  | 7 - 8 - 9 - 10 - 11 - 12 - 13 - 14 - 15 - 16 17 - 18 - 19 - 20 - 21 - 22 - 23 - 24 mm |
|------|---|--|

i  **1**
Mer information

<44.500 V



2490,-

Isolerad räddningsstånd

150.0913



Mer information

INTEGGSSETET FÖR ELEKTROMOBILITET

ecoLine



1

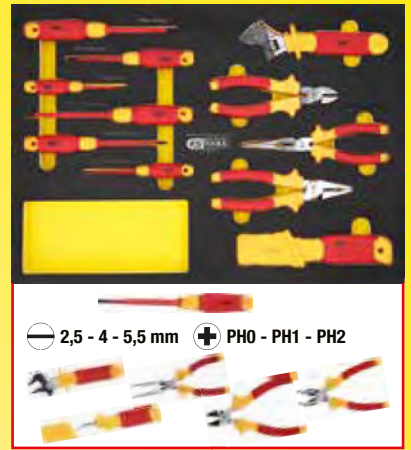

2

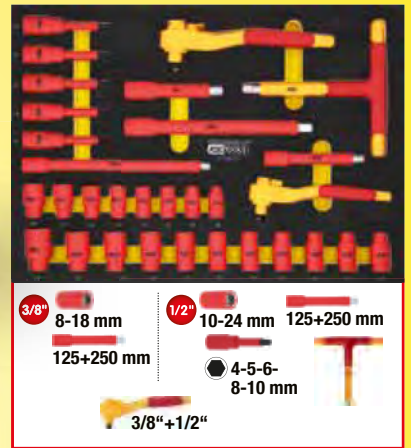

Fyrkantöppning för tillbehör

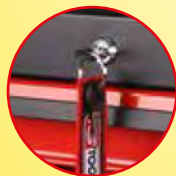

låsbar genom inbyggt cylinderlås



Arbetsplatta med 10 mm tjockt skumplastinlägg



med självindrag och SOFT-CLOSE-funktion



2 x rullbromsar och rotationsbromsar Ø hjul: 125 mm

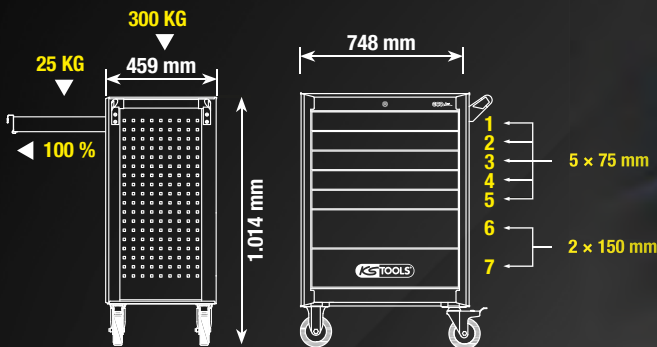

17930,-[^]

INKLUSIVE 42 VERKTYG

ECOline verktygsvagn med 42 isolerade verktyg för hybrid- och elfordon

117.6144

59330,-



Varningsskylt-hybrid-blixt



200 mm

917.3898



117.6172

3/8"+1/2" isolerad hylsnyckelsats med momentnyckel i skumgummiinsats, 72 delar

Varningsskylt hybrid brytare



Ø 200 mm

917.3897



117.6133

Isolerad nyckelsats i skumgummiinsats, 33 delar

Isoståndmatta, 1000 mm, tjocklek 3,0 mm

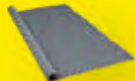

117.3819

Innerhandske



117.1660

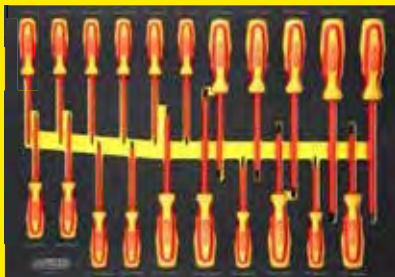

117.6121

ERGOTORQUE VDE skruvmejselsats i skumgummiinsats, 21 delar

Elektrikerskyddshandske med skyddsisolering, storlek 10, tjocklek 1, vit



117.1664

Elektriker-ansiktsskyddsskärm, klass 2



117.1796



117.6117

ERGOTORQUE VDE tångsats i skumgummiinsats, 17 delar

117.6155

PERFORMANCEplus verktygsvagn e10 med 164 isolerade verktyg för hybrid- och elfordon

140,-



117.0223

Taxskylt med blixtsymbol och magnet



STÖRST I SIN KLASS

140,-

117.0222

Takskylt med
blixtsymbol och sugkopp



210,-

117.0226

Skylt med blixtsymbol

970,-

117.1550

Avspärringsstolpe-sats
med kedja

2x

1940,-

117.1545

2 x Saxlås av plast



Elektromobilitetskatalogen
med 188 sidor finns på
www.kstools.com

i **4**
Mer information

Ø 22,0 - 28,0 mm

Ø 15,0 - 21,0 mm

Ø 17,0 - 25,0 mm

Kopplings-centrerings-verktyg-sats

150.2180 Ø 15,0 - 28,0 mm

130,-

i **11**
Mer information

150 kg

310 mm

450 mm

300 mm

5450,-

160.0910 **Universell växellådshållarsats**

i **3**
Mer information

- 1 Fyllningsverktyg A montering och demontering
- 2 Tappar ur olja, lågt flöde
- 3 Kontrollera fyllnadsnivån
- 4 Tappar ur olja, fullt flöde

350,-

9G-TRONIC

56 mm

20 mm

74,5 mm

9 mm

28,5 mm

39,5 mm

9 mm

152 mm

48 mm

150.9695

i **24**
Mer information

DEN MEST OMFATTANDE!

| | | |
|----------|--|--|
| 150.9261 | | 1/8-27 NPT Ford |
| 150.9262 | | BMW, Honda, Nissan etc. |
| 150.9263 | | VAG |
| 150.9264 | | VAG, Porsche |
| 150.9265 | | M10 x 1.0 VAG, Mini Cooper |
| 150.9267 | | M12 x 1.5 Mercedes |
| 150.9268 | | M24 x 1.5 VAG DSG |
| 150.9269 | | M22 x 1.5 VAG CVT |
| 150.9271 | | M18 x 1.5 Skoda |
| 150.9272 | | M30 x 1.5 VAG, Skoda |
| 150.9273 | | Universal Flexible 300 mm, Honda, Hyundai, Kia, etc. |
| 150.9274 | | 5/16-24 (UNF) Volvo |
| 150.9276 | | M18 x 1,5 Toyota / Lexus |
| 150.9277 | | M8 x 1,0 Nissan / Infinity |
| 150.9278 | | ATF-Adapter V.W, Passat |
| 150.9562 | | Nissan Juke M12 x 1,25 |
| 150.9563 | | Mini Cooper M14 x 1,5 |
| 150.9564 | | issan M10 x 1,5 |
| 150.9566 | | GM M12 x 1,75 |
| 150.9567 | | Mercedes 725-9G |
| 150.9102 | | VAG 7 DSG |
| 150.9103 | | VAG 7 DSG |
| 150.9104 | | VAG 7 DSG |

2760,-

INKLUSIVE ADAPTERSET MED 23 DELAR

NY!

150.9105 **Universal växellådsolja-Påfyllare inkl. 23 delars adaptersats**

i  **4**
Mer information



1550,-



Ø 30 mm

McPherson fjäderbensstöd för växellådslyft

160.0195

i  **7**
Mer information



6 mm

1380,-





Special stötdämpare-monteringshjälp-sats för stötdämpare med draganslagsfjäder

150.9545

TUV SUD **-TESTAT FÖR DIN SÄKERHET!**

i  **6**
Mer information

Universell för 90 % av alla vanliga fordonsfjädrar i personbil- och transporter-området



Ø 80 - 160 mm

Ø 140 - 195 mm

BELASTNING max 26000 N

6240,-

- Bäst lämpad för säker montering och demontering av Mc Pherson fjäderben
- Nödvändig vid byte av stötdämpare eller skruvfjädrar
- Universell för 90 % av alla vanliga fordonsfjädrar i personbil- och transporter-området
- Prisvärd och solid alternativ till vanliga fjäderspännare
- Också lämpad för koniska fjädrar och kulfjädrar
- Med TÜV-godkännande

500.8400 Universal fjäderspännare-sats

| Tekniska data: | |
|---------------------|-----------------|
| Fjädertryck max.: | 2600 kg |
| Spännvidd max.: | 355,0 |
| Fjädringskapacitet: | 80,0 - 195,0 mm |



-TESTAT FÖR DIN SÄKERHET!

i **11**
Mer information

TUV SUD
tuv-sud.com/pe-cert

1/2" x 1/2", 100 Nm

Ø 30 mm

Ø 90 - 140 mm

5150,-

500.8765 Audi och Seat teleskop-centreringsnyckel för interna fjädrar

FÖR FÖRLÄNGNING

i **2**
Mer information

Ø 95-110 mm

FÖR FJÄDERSPÄNNARE
500.8755 + 500.8765

1380,-

500.8770 par fjäderhållare Ø 95-110 mm

Användningsområden:
Mercedes E-Klass (W211 / W212), C-Klass (W204), GLA (X156), GLK (X204),
Ford Focus II (MK2), BMW 1er (E81), Volkswagen Passat (B8 / 3G)

FÖR FÖRLÄNGNING

i **9**
Mer information

TUV SUD
tuv-sud.com/pe-cert

Ø 30 mm

Ø 90 - 140 mm

Ø 75 - 115 mm

4680,-

500.8755 Universal teleskop-centerspännare-sats för ineliggande fjädrar

WARNING - ACHTUNG - ADVARSEL
ADVERTENCIA - AVERTISSEMENT

FÖR 95 % AV ALLA FORDON



Mer information

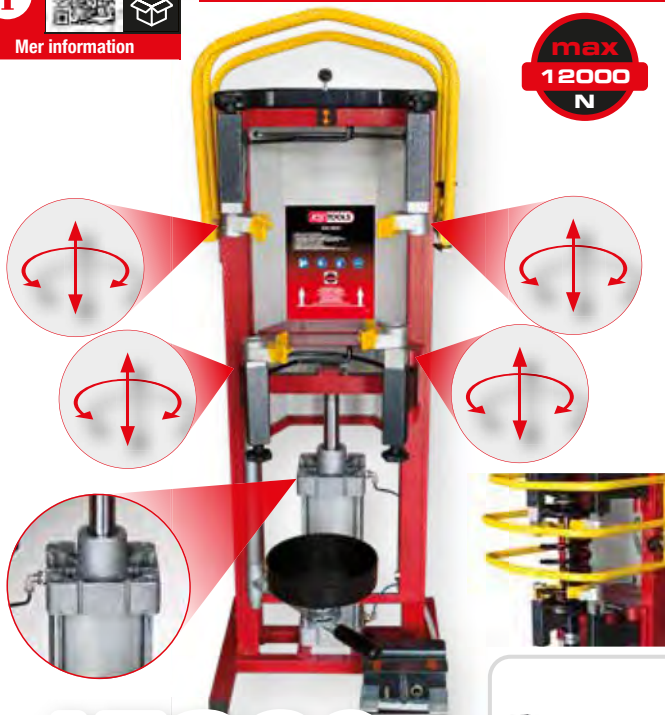

max
12000
N

15860,-

Tryckluft-ställ-fjäderspännare,
max. 10 bar

500.8800



Mer information



max
24000
N

22070,-

Tryckluft-ställ-fjäderspännare
med dubbelcylinder

500.8810



Mer information

- Enkel hantering
- Speciellt-verktygsstål
- ideal för mottagning av fjäderben
- optimal för säkert stånd vid installation och borttagning
- med 4 fixeringsbultar och 4 gängade bultar
- leverans sker med 2 stoppringar för montering

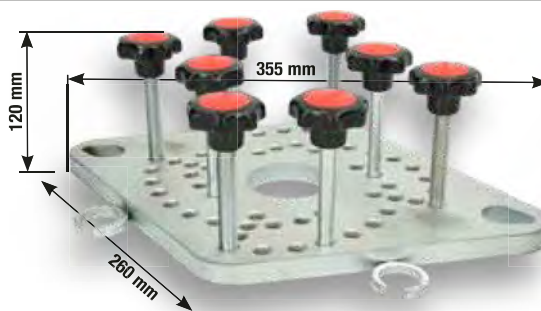

3900,-



500.8801 Adapterplatta för tryckluft-standard-fjäderspännare

FJÄDERSPÄNNARSATS INKLUSIVE ADAPTERPLATTA



Mer information

Tryckluft-ställ-
fjäderspännare
med adapterplatta

18620,-

500.8805



Mer information

Tryckluft-ställ-
fjäderspännare med
dubbelcylinder inkl.
adapterplatta

24830,-

500.8815

MODULO 2

MED ORDNING ÄR

KONFIGURERA EFTER DINA BEHOV

440.9051



16560,-

568 mm
XL
1429 mm

STÖRRE
ÄN
MAN
TROR

TLG
51

BROMS

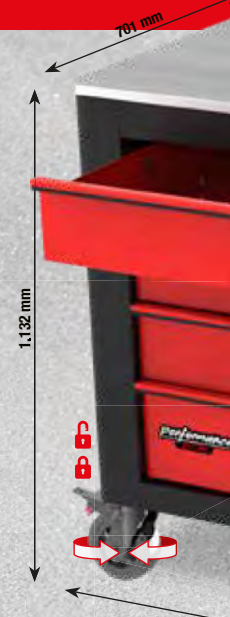

440.9087



34500,-

440.9025

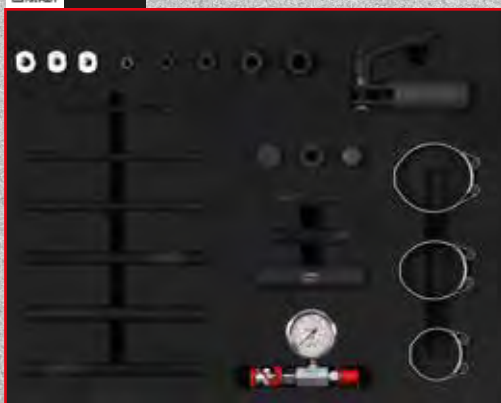

SILENTLAGER

TLG
87

**HYDRAULCYLINDER UTAN
MANÖVRERINGSVERKTYG**

440.9161



46920,-

440.9026

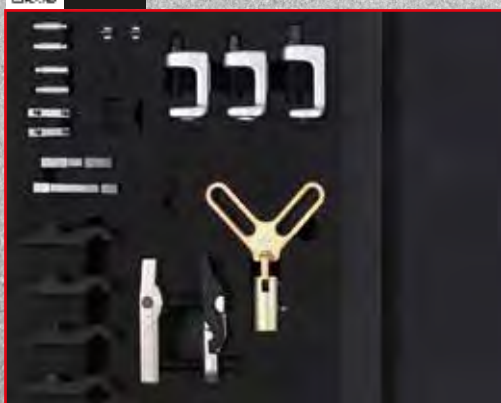

KOMPAKTHJULLAGER

TLG
61

AXEL

HÄLFTEN VUNNET

MODULO 2

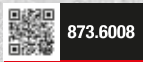

873.6008

PERFORMANCEplus P40 SVART/RÖD
verkstadsvagn med 4 lådor

38100,-

UTAN VERKTYG



12420,-

Hydraulpumpsats
med förvaring för P40

13800,-



440.9076



HJULLAGER

27600,-

11040,-



440.9061



STÖTDÄMPARE

26220,-



25



76



26



61

i  **1**
Mer information

1380,-

max. 8 bar

450 mm

1/4" PT

för universalaxelmanschetter

515.3100 Tryckluftmonteringsanordning för drivaxel damsker



i  **1**
Mer information

100 mm

255 mm

Ø 30 mm

690,-

150.1850 Universal länkaxel-avdragare



i  **1**
Mer information

VA FE

0 - 45 mm

270 mm

560,-

115.1056 Slangklämtång för vridmomentåtdragning



i  **1**
Mer information

max. 12 mm

690,-

115.1590 Fastspänningstång för rostfri kabelförbindare med kulförslutning

från 360,-

Rostfritt stål-buntband med kul

200 - 350 mm

| | | | | |
|----------|---|-----|--------------|-----------|
| 115.1591 |  | 100 | 4,6 × 200 mm | 360,- SEK |
| 115.1592 |  | 100 | 4,6 × 250 mm | 360,- SEK |
| 115.1593 |  | 100 | 4,6 × 350 mm | 400,- SEK |
| 115.1594 |  | 100 | 4,6 × 500 mm | 530,- SEK |



i  **1**
Mer information

10 mm

UNIVERSAL

560,-

700.5662 Klämmhålexpandereruttyg



i **1**
Mer information

350,-

Special bärlänkshylsa till Mercedes

150.1721 Mercedes W167, W205, W213, W238, W253, W25

i **6**
Mer information

5110,-

Vibro-Impact tryckluft-mejselhammare-sats

515.3880

VIPRO

15280316

110 mm

10 mm

110 mm

10 mm

130 mm

10 mm

100 x 25 x 12 mm

31 x / sec.

i **3**
Mer information

450,-

Klämskruvar-utdrivarsats

700.5635

10 mm

i **1**
Mer information

2210,-

Vibro-Impact upplåsningsverktyg för tryckstång

150.1608

- Vibrationsstött lösande av spårstag, konterlåsningar eller skruvkopplingar i axelområdet osv.
- den speciella vibrerande dornen applicerar en stötimpuls på skruvförbandet som ska lossas, vilket lossar rost och stödjer lossningsprocessen
- Tryckluft-mejseladapter (10 mm) för användning med vanliga tryckluft-mejsel-slaghammare

290 mm

10 mm

27 mm

65 mm



Mer information



2340,-

700.1495 Universal bärmshållare med kedja



- Genom flexibel kedja kan knäleder i olika modeller tryckas ned säkert och utan större kraftinsats



Mer information

1690,-

- Stabil trapets-gängspindel
- Fotpedal för finjustering (20mm)
- Ideal verkstadshjälp i många situationer



160.0342 Telskop-stöd



Mer information



1250,-

911.6187 Teleskop ledat-rullhuvud-hävstång



Mer information

1380,-



700.1465 Axelspeltestare



Mer information

1000 W
6240,-
1000 W
6240,-

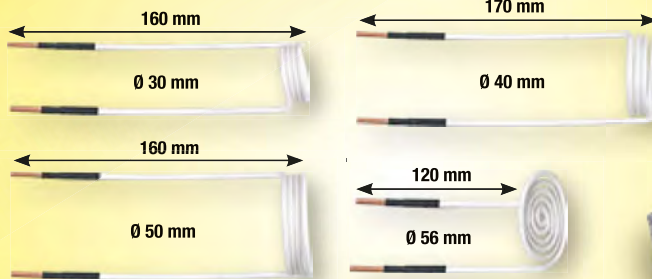

500.8605 Induktionsvarmluftspistol-sats



OPTIONELLT
1800,-
 500.8440

2:A GENERATIONEN - 2:A GENERATIONEN - 2:A GENERATIONEN



Mer information

HAKA PÅ!

NY 210,-

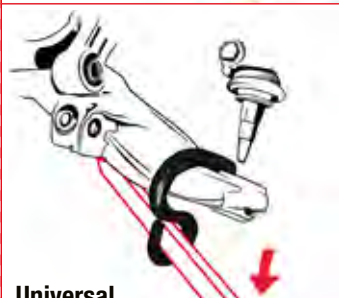
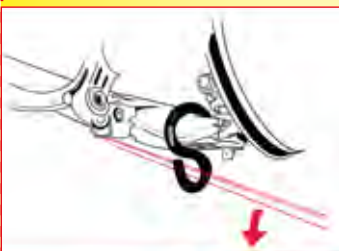

Universal axelspak

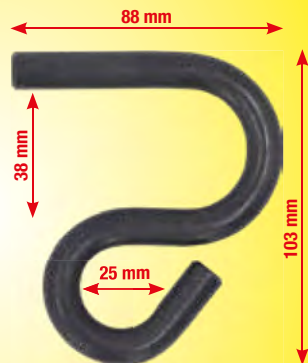

speciell form tillåter att den fästs mycket nära på kulle

speciell spak för korrekt och skonsam montering och demontering av axels delar

700.1499



Mer information

1 x [Image of part 1]
 2 x [Image of part 2]
 9 x [Image of part 3]
 13 x [Image of part 4]

Ø1: 34 - 80 mm Ø2: 44 - 90 mm

Ø 38 - 40 - 42 - 50 - 52
 54 - 62 - 64 - 66 mm

Ø 34 - 36 - 44 - 46
 48 - 56 - 58 - 60 - 68
 70 - 72 - 75 - 80 mm

M10x1,5
 M12x2,0
 M14x2,0
 M16x2,5

4 x [Image of part 5]

700.1550 Tryck-och draghysesats



4140,-

i **22**
Mer information

700.2355 Nivåtryckhyllsors-sats **6900,-**

42 40 38 36 34
32 30 28 26 24
#1
#2
#3
#4
M12
M10
M12 M10
TR20

Ø / mm

i **4**
Mer information

1110,-

150.1125 Inre styrlid- specialnyckel-sats **1110,-**

30-35 mm 35-40 mm 40-45 mm
360 mm
1/2" / 32 mm

i **2**
Mer information

M12

NY

115 mm 72 mm

280,-

Kraftbitshyllsats för XZN skruvar

515.0595 1/2"

i **30**
Mer information

700.1530 Universell hjulnavs- och länkakselavdragarsats **3110,-**

1 x Ø 90 - 130 mm
1 x
4 x M 14
4 x M12 x 1,25
M12 x 1,5
M12 x 1,25
M12 x 1,5
M14 x 1,5
1 x M18 x 2,5 x 230 mm
M57 x 2
4,3 Kg

MINDRE PERSONALBEHOV, MER VINST.

LYFTA UT SKIVA UTAN HJÄLP!

140.2630

Universalutrustning enmans för vindrutebyte

- idealisk för korrekt och skonsam demontering av limmade vindrutor samt de flesta bak- och sidorutor
- med större styrrullar och därigenom lägre kraftansträngning och minimering av risken för trådbrott
- Sprutornhållare omedelbart framför vindrutan, därigenom elimineras i de allra flesta fallen kostnaderna för demonteringen av trimdelarna
- Enkel enmans-manövrering
- särskilt högkvalitativ pumpsug för säkert fäste på rutan



ONE MAN CUT



Proffs-skyddstavla-set, 4 delar
2x 270x200 mm + 2x 450x300 mm

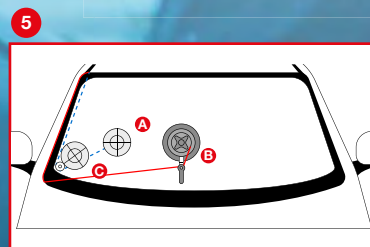
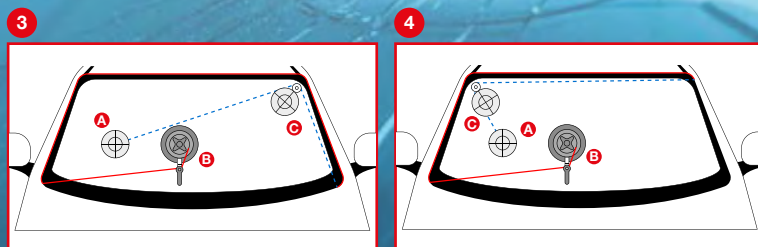
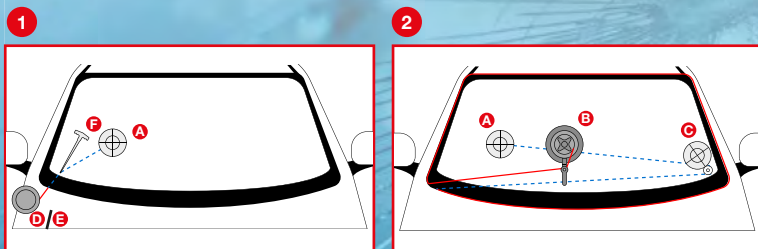

8280,-

Inklusive



NY

0 20 mm

155 mm

210,-

ÄVEN FÖR DOT5.1, ENV4 OCH ENV6

- Dot3 ✓
- Dot4 ✓

150.1969 Bromsvätskeprovare för DOT och ENV

1

Mer information

VITON®

EKM

390,-

150.8258 Pumpsprejflaska för bromsrengöring

Speciellt för bromsrengörare

2

Mer information

160,-

150.1935 Universal kroksats, formbar

2

Mer information

210,-

150.2235 Universal kroksats, stel

12

Mer information

690,-

150.2400 Skivbromsskruvar-specialhylsnyckel-sats

1/2" 11,5 mm 14 mm 15 mm 20 mm AS 22 mm

1/4" 9 x 20 mm

3/8" 7 x 72 mm
7 x 92 mm
9 x 50 mm
11 x 100 mm

3/8" 7 x 25 - 8 x 25 mm

41

Mer information

1380,-

150.1970 Bromskolv-återställningsverktyg-sats



Mer information

UNIVERSAL-GENIET



UNIVERSAL
För 95% av alla fordon



2 stift



3 stift



3/8"



4 stift

1800,-



150.2440 Universal bromskolv-återställnings-verktyg-sats



Mer information

9660,-



5L



160.0700 Bromsunderhållsutrustning KS5

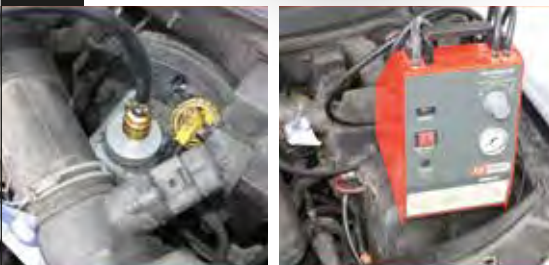

Mer information

690,-



universellt justerbar



Max. 70 mm

Min. 28 mm

160.0718 Universal ventilationsadapter, justerbar



Mer information

TOYOTA & LEXUS

NY



240,-

160.0719 Universal-luftarrör-adapter för Toyota och Lexus

i **6**
Mer information

STOP

1.200 mm

970,-

11 mm
10 mm
9 mm
8 mm
7 mm

160.0725 Bromssystem-avluftningsnyckel-sats

i **11**
Mer information

DEN KOMPLETTA

STOP

1.200 mm

9x12 mm

180 mm

NY

11 mm
10 mm
11 mm
7 mm
11 mm
60 mm
70 mm
75 mm
85 mm

1040,-

518.0320 Bromsavluftningsverktygssats för VAG

i **1**
Mer information

4,75 mm (3/16")

21 mm
31 mm
41 mm
61 mm
76 mm

560,-

120.1006 Bromsledningsbockverktyg

i **1**
Mer information

4,75 mm (3/16")
6,35 mm (1/4")

420,-

120.1004 Bromsledningsriktverktyg/-bockverktyg

1 Böja

2 Duplicera

3 Rikta

OUT IN

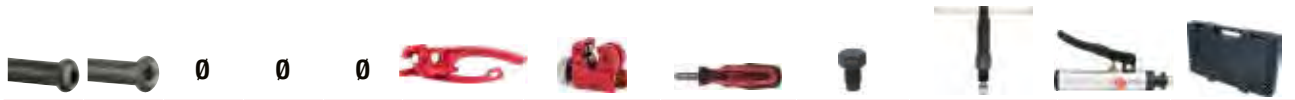

| | | DIN | SAE | 4,75 mm | 5,0 mm | 6,0 mm | med rörböj | med rörkap | med röravgradare | mekanisk | med hydraulspindel | Handpump | i väskan |
|---|----------|-----|-----|---------|--------|--------|------------|------------|------------------|----------|--------------------|----------|----------|
| 1 | 122.1215 | ✓ | ✗ | ✓ | ✗ | ✗ | ✗ | ✗ | ✗ | ✓ | ✗ | ✗ | ✗ |
| 2 | 122.1290 | ✓ | ✓ | ✓ | ✓ | ✓ | ✓ | ✓ | ✓ | ✗ | ✓ | ✗ | ✓ |
| 3 | 122.1260 | ✓ | ✓ | ✓ | ✓ | ✓ | ✗ | ✗ | ✗ | ✗ | ✗ | ✓ | ✓ |

Mer information

4

STOP

690,-

4,75 mm

1 **FLAREFIXeco 4,75 mm universal bromskonisk-sats**

122.1215

Mer information

16

FLAREFIX

DIN SAE

2350,-

2 **FLAREFIX 1 universal bromslednings-koningsenhet-sats med hydraulcylinder**

122.1290

3,0-12,0 mm

3,0-6,0 mm

3,0-16,0 mm

4,75-5,0 mm, SAE

4,75 mm, 3/16"

6,0 mm, SAE

5,0 mm

4,75-5,0-6,0 mm, SAE-90°

6,0 mm

4,75-5,0 mm, DIN

6,0 mm

6,0 mm, DIN

6,0 mm

M12x1,25

6,0 mm

Mer information

11

HYDRAULISKT, PRAKTISKT, BRA!

FLAREFIX II

Hydraulic

DIN SAE

4140,-

3 **FLAREFIX 2 universell-bromslednings-flänsningsenhet-sats med hydraulcylinder**

122.1260

M12 x 1,25 mm

4,75-5,0 mm, SAE

6,0 mm, SAE

4,75-5,0-6,0 mm, SAE-90°

5,0 mm

4,75-5,0 mm, DIN

4,75 mm, 3/16"

6,0 mm, DIN

6,0 mm

M12x1,25

6,0 mm



Mer information



3/8"



350,-

3/8" specialprofilsats för oljeservice med oljeavtappningskruvar av plast, 9 delar

150.1040



Mer information



970,-



- Verktyg för planing av tätningssäten på oljeavtappningspluggar
- Plan sätestätning säkerställer en perfekt tätning i området i oljeavtappningspluggen
- exakt centrerering och riktning av tätningssytan
- Sats inklusive anpassning för original-oljeavtappningsplugg och överstorleks-reparationsgångskruv
- I stabil plastlåda

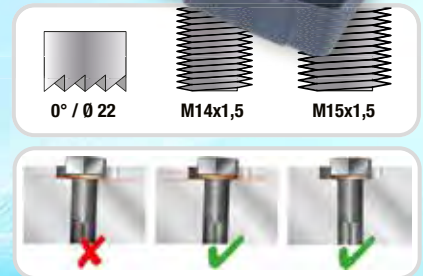

150.1485

Oljeavtappningspluggar-tätningssäte-planfräs-sats



Mer information



7,5 liter

Ø 385 mm

180,-



150.9359

Oljedroppskål 7,5 liter

i  **30**
Mer information

1/2" 21 mm
Ø 63 - 102 mm

1380,-

3/8" oljefilternyckelsats

65-14, 65/67-14, 66-6, 68-14, 73-14, 74-15, 74/76-15, 75/77-15, 76-8, 76-12, 76-14, 76-30, 78-15, 80-15, 80/82-15, 86-18, 86-16, 90-15, 92-10, 93-15, 93-36, 93-45, 95-15, 96-18, 100-15, 106-15, 108-15, 108-18



i  **24**
Mer information

2,0 L

1380,-

150.9130 **MASTER Oljepåfyllningstratt-sats med vridbar vinkelarm**

VW Lexus Lotus Ford Nissan
Subaru Mitsubishi Land Rover Hyundai Audi
Chrysler Toyota Citroën Volvo Cadillac
Citroën Buick Volvo Buick universal



i  **4**
Mer information

FÖR VAG

Med böjbar vinkelarm för svår åtkomliga ställen

2,0 L

210,-

150.9155 **Oljepåfyllningstratt med vridbar vinkelarm för VAG**



UPP PÅ LYFTEN OCH SÄTT IGÅNG!

av massivt gummi

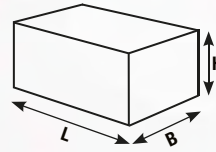

| Delar | L mm | B mm | H mm | | |
|----------|---------|---------|---------|------|-----------|
| 160.0476 | 1 | 160 | 120 | 20 | 70,- SEK |
| 160.0477 | 1 | 160 | 120 | 30 | 100,- SEK |
| 160.0478 | 1 | 160 | 120 | 40 | 130,- SEK |
| 160.0479 | 1 | 160 | 120 | 60 | 180,- SEK |
| 160.0480 | 1 | 160 | 120 | 80 | 240,- SEK |
| 160.0481 | 1 | 160 | 120 | 100 | 290,- SEK |
| 160.0482 | 1 | 160 | 120 | 115 | 330,- SEK |
| 160.0483 | 1 | 116,5 | 116,5 | 36,5 | 90,- SEK |
| 160.0499 | 1 | 160 | 120 | 85 | 250,- SEK |



PE (Polyetylen)

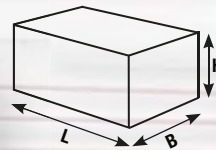

| Delar | L mm | B mm | H mm | | |
|----------|---------|---------|---------|-----|-----------|
| 160.0437 | 1 | 250 | 150 | 55 | 210,- SEK |
| 160.0438 | 1 | 250 | 150 | 100 | 380,- SEK |
| 160.0486 | 1 | 340 | 150 | 55 | 280,- SEK |
| 160.0489 | 1 | 340 | 130 | 100 | 450,- SEK |



tillverkade av massivt gummi med förstärkt kärna

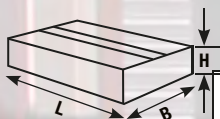

| Delar | L mm | B mm | H mm | | |
|----------|---------|---------|---------|----|-----------|
| 160.0484 | 1 | 373 | 100 | 35 | 560,- SEK |



av mycket styv plast



Model 3 ✓
Model S ✓
Model X ✓
Model Y ✓



av massivt gummi

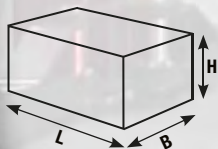

| Delar | L mm | B mm | H mm | | |
|-------------|---------|---------|---------|----|-----------|
| 160.0391-TD | 4 | 155 | 125 | 35 | 490,- SEK |



av massivt gummi

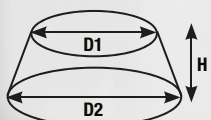

| Delar | D1 mm | D2 mm | H mm | | |
|----------|----------|----------|---------|----|-----------|
| 160.0485 | 1 | 78 | 105 | 60 | 140,- SEK |



160.0460 Tesla Model 3, S, X, Y

330,-



av gummi och stålplatta

Mer information

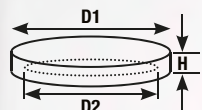

STÅL



| | D1 mm | D2 mm | H mm | Ravaglioli | Grazia | OMCN | Intertech | MAHA | Werther | Nussbaum | AMI | Twin Bush | Sirio | Space | Launch | RP Tools | J.A. Becker | ATH | HOFMANN | Hermann | | |
|----------|----------|----------|---------|------------|--------|------|-----------|------|---------|----------|-----|-----------|-------|-------|--------|----------|-------------|-----|---------|---------|--|-----------|
| A | 160.0463 | 120 | 113 | 22 | | | | ✓ | | | | | | | | | | | | | | 130,- SEK |
| B | 160.0465 | 123 | 108 | 25 | ✓ | | | | ✓ | | | | | | | | | | | | | 130,- SEK |
| C | 160.0475 | 120 | 110 | 19 | | | | | | | | | | | | | ✓ | ✓ | ✓ | ✓ | | 130,- SEK |



I gummi

Mer information

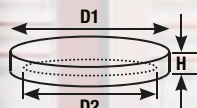

GUMMI



| | D1 mm | D2 mm | H mm | Ravaglioli | Grazia | OMCN | Intertech | MAHA | Werther | Nussbaum | AMI | Twin Bush | Sirio | Space | Launch | RP Tools | J.A. Becker | ATH | HOFMANN | Hermann | | |
|----------|----------|----------|---------|------------|--------|------|-----------|------|---------|----------|-----|-----------|-------|-------|--------|----------|-------------|-----|---------|---------|--|-----------|
| A | 160.0466 | 125 | 120 | 24 | | | | | | ✓ | ✓ | | | | | | | | | | | 170,- SEK |
| B | 160.0467 | 140 | 130 | 25 | | | | | | | | ✓ | | | | | | | | | | 90,- SEK |
| C | 160.0468 | 100 | 85 | 14 | ✓ | | | | | | | | ✓ | ✓ | | | | | | | | 70,- SEK |
| D | 160.0464 | 120 | 113 | 23 | | | | ✓ | | | | | | | | | | | | | | 70,- SEK |
| E | 160.0469 | 120 | 108 | 32 | | | | | | | | ✓ | | | ✓ | ✓ | | | | | | 110,- SEK |
| F | 160.0470 | 130 | 125 | 14 | ✓ | | | | | | | | ✓ | ✓ | | | | | | | | 70,- SEK |
| G | 160.0471 | 140 | 125 | 30 | | | | | | | | ✓ | | | | | | | | | | 110,- SEK |
| H | 160.0472 | 150 | 130 | 23 | ✓ | | | | | | | | | | | | | | | | | 100,- SEK |
| I | 160.0473 | 120 | 105 | 30 | | | | | | | | ✓ | | | | | | | | | | 100,- SEK |
| J | 160.0474 | 120 | 110 | 19 | | | | | | | | | | | | | ✓ | ✓ | ✓ | ✓ | | 70,- SEK |
| K | 160.0490 | 100 | 80 | 21 | ✓ | | | | | | | | | | | | | | | | | 60,- SEK |
| L | 160.0491 | 120 | 108 | 26 | ✓ | ✓ | | | | | | | | | | | | | | | | 70,- SEK |
| M | 160.0492 | 120 | 110 | 26 | ✓ | ✓ | | | | | | | | | | | | | | | | 70,- SEK |
| N | 160.0493 | 145 | 108 | 24 | ✓ | | ✓ | | | | | | | | | | | | | | | 110,- SEK |
| O | 160.0494 | 145 | 135 | 26 | ✓ | | | | | | | | | | | | | | | | | 100,- SEK |
| P | 160.0495 | 160 | 135 | 28 | | | ✓ | | | | | | | | | | | | | | | 100,- SEK |
| Q | 160.0496 | 140 | 103 | 25 | | | | | | ✓ | | | | | | | | | | | | 110,- SEK |
| R | 160.0497 | 150 | 127 | 25 | ✓ | | | | | | | | | | | | | | | | | 90,- SEK |
| S | 160.0498 | 140 | 132 | 28 | | | | | | | | | | | | | | | | | | 130,- SEK |

i **1**
Mer information



110,-

800.0156 magnethölje i plast Ø 150 mm



i **1**
Mer information



330 mm







140,-

150.2032 däckventilspak i metall 330 mm

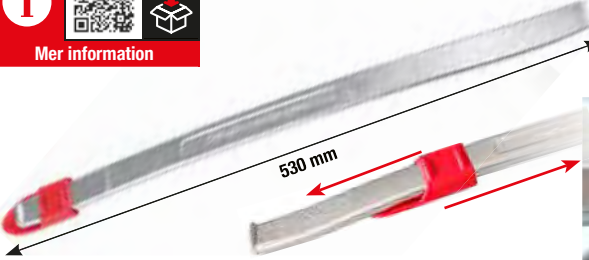
i **1**
Mer information



530 mm



390,-

911.8135 runflat-däckjärn och monteringsjärn

i **1**
Mer information

690,-



800.0190 metall-magnethållare, 390 mm

i **1**
Mer information



600 mm



0 - 12 bar



1/4" PT

280,-

515.1950 Tryckluft-däckpåfyllare

i **1**
Mer information

KALIBRERAD



400 mm



0 - 10 bar



1/4" PT

860,-

515.1960 Kalibrerad tryckluft-däckfyllningsmätare

i **5**
Mer information

790,-



60 x 100 mm



70 g







9 mm

OPTIONELLT
60 stycken

250,-

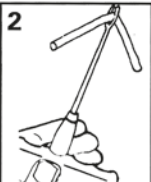
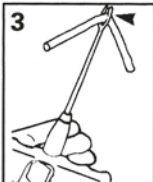
150.1072

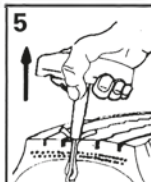
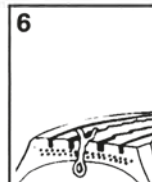
150.1070 Vulkaniseringsset för däck för personbilar, inklusive 100 mm gängor

i  **1**
Mer information

1250,-

Aluminium-hjulnavsslipsats,
Ø 150 mm, inre-Ø 90 mm

100.5080

OPTIONELLT
490,-
100.5077

FÖRE: **EFTER:**

i  **4**
Mer information

NY

8 mm 10 mm 8 mm 8 mm

OZ Special-aluminium-fälgar-jack-mutter-sats för de flesta OZ-fälgar

210,-

515.0795 $\frac{1}{2}$ "

i  **3**
Mer information

560,-

1/2" spiralprofil hyllsats,
3-delars, 17-21 mm

913.1270 $\frac{1}{2}$ " 17 - 19 - 21 mm

i  **2**
Mer information

$\frac{1}{2}$ "

19,5 mm 21,5 mm 18,5 mm 20,5 mm

Special-aluminiumfälg-krafthyllsats för
Ford, 18,5 / 19,5 / 20,5 / 21,5 mm

390,-

515.0895 $\frac{1}{2}$ " 18,5 - 19,5 - 20,5 - 21,5 mm

i  **1**
Mer information

TILL MERCEDES

max. 75 Nm

250,-

1/2" Kraft-torsionsförlängning, 75 Nm

515.1491 $\frac{1}{2}$ "



Mer information



Hjulsäkrings-demonteringssats



830,-

913.1480 18 - 19 - 20 - 21 - 22 - 23 - 24 - 25 mm



Mer information

Fälgläs-demonteringssats



∅ 21,5 mm

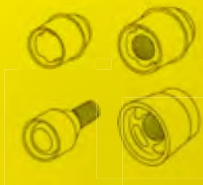

∅ 16 mm



∅ 21,5 mm

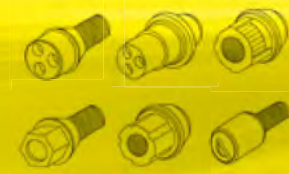

∅ 10,5 mm



∅ 9,5 mm



kan användas på båda sidor

913.1430



i med handskydd



14 mm
skumgummi

1940,-



UNIVERSALGENIAL - ANPASSAR SIG TILL VARJE PROFIL!

ROBUSTA 1/2" ALUMINIUMFÄLGAR KRAFTUTTAGSSATSER

1

Mer information



250,-

515.1070 1/2" 17 - 19 - 21 mm

2

Mer information



350,-

515.0870 1/2" 15 - 17 - 19 - 21 - 22 mm

3

Mer information

970,-



1/2" 15 - 17 - 19 - 21 - 22 - 23 - 24 mm
7/8" 17 mm MS21

515.0890

4

Mer information



1940,-

DEN KOMPLETTA ALLROUNDMASKINEN

515.0885 1/2" 15 - 17 - 19 - 21 - 22 - 23 - 24 mm 7/8" 17 mm MS21 17 - 19 - 21 mm 18,5 / 19,5 - 20,5 / 21,5 - 17,5 / 22,5 mm

| | 515.1072 15 mm | 515.1073 17 mm | 515.1075 19 mm | 515.1076 21 mm | 515.1077 22 mm | 515.1078 23 mm | 515.1079 24 mm | 515.1089 Tesla 7/8" | 515.2055 Mercedes 17 mm | 515.2060 Hyundai KIA MS21 | 913.1271 Spiralutdragningsmutter 17 mm | 913.1272 Spiralutdragningsmutter 19 mm | 913.1273 Spiralutdragningsmutter 21 mm | 515.0896 Ford 18,5 / 19,5 mm | 515.0897 Ford 20,5 / 21,5 mm | 515.0899 Ford 17,5 / 22,5 mm | 515.1134 Kraftförlängning, 75 mm |
|----------|-------------------|-------------------|-------------------|-------------------|-------------------|-------------------|-------------------|------------------------|----------------------------|------------------------------|---|---|---|---------------------------------|---------------------------------|---------------------------------|-------------------------------------|
| 1 | X | ✓ | ✓ | ✓ | X | X | X | X | X | X | X | X | X | X | X | X | X |
| 2 | ✓ | ✓ | ✓ | ✓ | ✓ | X | X | X | X | X | X | X | X | X | X | X | X |
| 3 | ✓ | ✓ | ✓ | ✓ | ✓ | ✓ | ✓ | ✓ | ✓ | ✓ | X | X | X | X | X | X | X |
| 4 | ✓ | ✓ | ✓ | ✓ | ✓ | ✓ | ✓ | ✓ | ✓ | ✓ | ✓ | ✓ | ✓ | ✓ | ✓ | ✓ | ✓ |

i **1**
Mer information

uppladdningsbar med USB-C-kabel (ingår)

240,-

350 Lumen

UV LED

POWER-AAA Li-Ion 800mAh

med laserpekare

LED COB Stripe inspektionslampa 350 Lumen med UV-spot-LED och laserpekare

150.4400

i **1**
Mer information

140 mm

85 Lumen

210,-

25 m

perfectLight ficklampa 85 Lumen

150.4370

2 x AA

i **1**
Mer information

MAX. 350 Lumen

MAX. 100 Lumen

270°

MÅSTE HA! FÖR VERKSTAD ELLER UTMOMHUS

210,-

150.4520

Li-Ion 3,7 V 1200 mAh

Power Display

Rörelsesensor

Sensoromkopplare

USB-C

On/Off

XPE LED 2 ljusnivåer

COB LED 3 ljusnivåer

Storleksjustering

| Modi | COB 100% | COB 40% | COB rot | XPE 100% | XPE 40% |
|------|---------------------|---------|---------|---------------------------|---------|
| LED | 270° 3 Watt COB LED | | | 1 Watt High Power XPE LED | |
| 40% | 350 LM | 150 LM | - | 100 LM | 40 LM |
| | 3 h | 6 h | 8 h | 4 h | 8 h |

Mer information

250,-

360°

250 Lumen

500 Lumen

USB

ON OFF

1 200 mAh litiumjonbatteri (ingår)

180°

eller

3x AAA-batterier (ingår ej i leveransen)

inklusive USB powerbank-funktion

| | |
|-------|-------|
| 20 % | ● |
| 40 % | ●● |
| 60 % | ●●● |
| 80 % | ●●●● |
| 100 % | ●●●●● |

150.4510

max. 3 h

3 h

+

IP65

Mer information

280,-

130 Lumen

300 Lumen

USB-A OUT

USB-C IN

ON OFF

integrerat litiumjon-batteri 1.200 mAh

| | |
|-------|-------|
| 20 % | ● |
| 40 % | ●● |
| 60 % | ●●● |
| 80 % | ●●●● |
| 100 % | ●●●●● |

150.4505

max. 3 h

3 h

+

IP65

Mer information

230,-

60 Lumen

150 Lumen

Micro USB

360°

ON OFF

| | |
|-------|-------|
| 20 % | ● |
| 40 % | ●● |
| 60 % | ●●● |
| 80 % | ●●●● |
| 100 % | ●●●●● |

150.4495

max. 3,5 h

2,5 h

IP20

Mer information

520,-

250 Lumen

550 Lumen

USB-A OUT

USB-C IN

ON OFF

| | |
|-------|-------|
| 20 % | ● |
| 40 % | ●● |
| 60 % | ●●● |
| 80 % | ●●●● |
| 100 % | ●●●●● |

150.4490

max. 3,5 h

3 h

+

IP65

i  **11**
Mer information



20-200 Nm

1/2"

500 mm

125 mm

10 mm 13 mm 17 mm 19 mm 21 mm 24 mm

17 mm 19 mm 21 mm

1660,-

516.2400 1/2" 10 - 13 - 17 - 19 - 21 - 24 mm

KS TOOLS
KALIBER-KONFORMITÄTSERKLÄRUNG
DIN EN ISO 6789
Certifikat
Noggrannhet

i  **8**
Mer information

FÖR DÄCKBYTE PÅ REKORDTID

21 mm **19 mm** **17 mm**

1/2"

1600 Nm

2 x

Ø 150 mm

0 - 12 bar

10 m

NY

1660,-

THE DEVIL

Er återförsäljare

 **4 042146 956687**
LL23-06SE_SEK

KS Tools Werkzeuge - Maschinen GmbH
Seligenstädter Grund 10 - 12
D-63150 Heusenstamm
TYSKLAND

Mail: aftersales@kstools.com
Web: www.kstools.com

515.2100

Priserna i denna broschyr ersätter alla tidigare priser. Endast försäljning via återförsäljare. Vi reserverar oss för eventuella tryckfel och tekniska ändringar. Alla priser i SEK exklusive moms gäller tills 2024-09-30.